

# PRODUCT CATALOG



**VERTICAL CABLE**  
*Simply Connect.*



1989

Chiptech, Inc., the parent company of Vertical Cable was founded.



2006

VC was established, growing into a nationwide distributor of low voltage cable and connectivity with two distribution centers in Florida and California.



2013

VC opened its New York distribution center while simultaneously launching its sister company, Trans Cable International, a U.S.-based manufacturing facility in Bonham, Texas.



2024

Newest VC distribution center in Houston, TX.



2026

VC continues to deliver reliable, high-performance solutions—supporting the systems behind modern installations.



# Family-Owned. Built on Values.

---



Vertical Cable is a family-owned and operated company with leadership spanning generations. That foundation drives our focus on trust, accountability, and long-term partnerships—because strong relationships are at the core of everything we build.

**MIKE  
SATTARZADEH**  
**CEO**

*“Slow and steady wins the race.”*

Guiding the company’s long-term vision, product innovation, and strategic growth—while staying grounded in the values that built the business.



**MAHSA  
SATTARZADEH**  
**COO**

*“It is not if, but when.”*

Leading operations with a focus on efficiency, team alignment, and delivering consistent, high-quality experiences across every customer interaction.



***Built on experience. Driven by the next generation.***



With multiple stocking locations across the U.S., Vertical Cable delivers fast, reliable service nationwide — **your one-stop shop for low voltage and fiber solutions.**

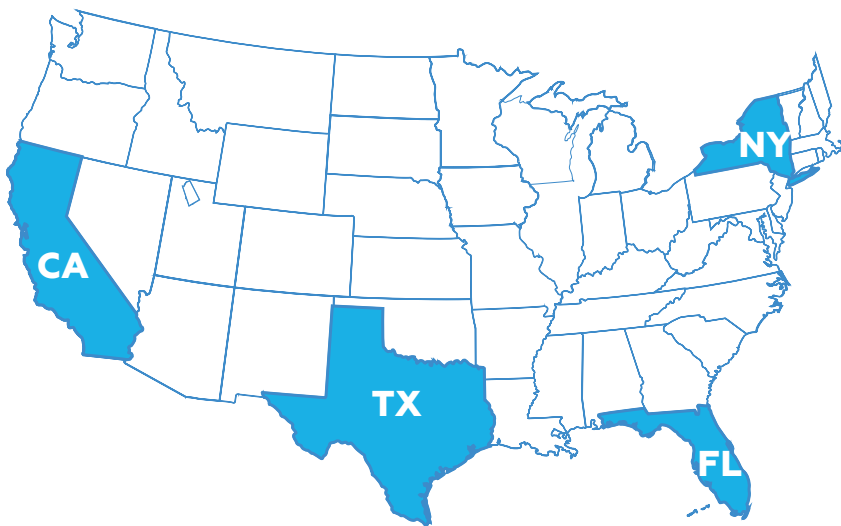

**West Coast:** Our Murrieta, California facility supports customers across the Western U.S., Central regions, and Alaska. **North East:** Our New Windsor, New York facility serves Canada, the East Coast, and Central U.S. Southern Region: **Our headquarters** in North Miami, Florida supports Florida, the Caribbean, and South America. Our Houston, **Texas location** serves the TOLA region (Texas, Oklahoma, Louisiana, Arkansas).

We also operate a state-of-the-art manufacturing facility focused on high-quality plenum copper cables, along with value-added services such as private labeling. Our Bonham, Texas fiber facility stocks a wide range of optical fiber cables and serves as a central hub for managing and fulfilling bulk fiber orders.

## FLORIDA (HQ)

**Headquarters**

2885 SW 30th Avenue, Pembroke Park, FL 33009

**Business Hours:**

Monday - Friday 8:00 AM - 5:00 PM (EST)

800-749-2447 phone

## CALIFORNIA

**Address:**

41715 Cherry Street, Murrieta, CA 92562

**Business Hours:**

Monday - Friday: 7:00 AM - 4:00 PM (PST)

## NEW YORK

**Address:**

9 Tarkett Drive, Unit 30, New Windsor, NY 12553

**Business Hours:**

Monday - Friday 8:00 AM - 5:00 PM (EST)

## TEXAS

**Address:**

4647 Pine Timbers St., Ste 120, Houston, TX 77041

**Business Hours:**

Monday - Friday 8:00 AM - 4:30 PM (CST)



**VerticalCable.com**

# T A B L E O F

## 1. COPPER

- 8 CAT6A
- 14 CAT6
- 22 CAT5E
- 30 CAT3
- 32 Audio
- 34 Coax
- 42 Access Control
- 44 Security
- 48 Fire Alarm
- 50 Thermostat Wire
- 51 LED Cable

### 1.1. COPPER CONNECTIVITY

- 54 V-Max Keystone Jacks
- 56 Keystone Couplers
- 57 Inline Couplers
- 57 Junction Boxes
- 59 Keystone Wall Plates
- 61 Surface-Mount Mounting Boxes
- 61 Dry-Wall Brackets
- 61 Feedthrough Wall Plates
- 62 Surface Mount Boxes
- 64 Patch Panels
- 70 Panel Covers
- 70 Network Brush Panels
- 72 Patch Cords
- 76 HDMI Digital Cables and Accessories
- 77 Keystone Inserts and Coax Connectors
- 78 Modular Plugs
- 79 Slip-On Boots
- 80 Tools

## 3. CABLE MANAGEMENT & RACKS

- 122 Raceways and Accessories
- 123 Cable Ties
- 123 Hook and Loop Strap
- 123 Mounting Bases
- 124 J-Hooks and D Rings
- 125 Bridle Rings
- 126 Wire Managers
- 127 Support Brackets
- 127 Screws, Washers & Cage Nuts
- 127 Power Strip
- 128 Wall-Mount Brackets
- 130 Open Rack Enclosures
- 131 Wire Managers
- 132 Wall-Mount Racks
- 136 Wall-Mount Enclosures
- 138 Network & Server Cabinets
- 139 DVR Lockboxes & Mounting Brackets
- 140 Shelves

# C O N T E N T S

## 2. OPTICAL FIBER

- 84 Outside Plant (OSP)
- 86 Inside Plant (ISP)

### 2.1. FIBER CONNECTIVITY

- 90 Wall Outlets & Surface-Mount Boxes
- 92 Rack-Mount Panels
- 92 Cable Management Bars
- 93 Rack-Mount Enclosures
- 94 Wall-Mount Enclosures
- 96 Wall-Mount Boxes & Accessories
- 98 Connectivity Node
- 99 DIN-Rail Modular Cassettes
- 100 LGX Adapter Plates
- 102 Optical Fiber Adapters
- 104 Modular Connector Assemblies
- 106 Mechanical Plugs
- 107 Epoxy Plugs
- 108 Mechanical Splicing Tool Kit
- 108 Cleavers
- 109 Fiber Cleaning Kit
- 110 Splice Trays/Cassettes
- 111 Sleeves and Splice Holders
- 111 Fan-Out Kits
- 112 Pigtailed
- 113 Optical Fiber Patch Cords
- 114 OSP Transition Boxes
- 115 OSP Splice Closures
- 116 OSP Tension Clamps
- 116 OSP Hooks and Brackets
- 117 OSP Steel Banding
- 118 Tools
- 119 VFL, Light Source, Power Meter
- 119 Test Leads

## 4. INDUSTRIAL & HARSH ENVIRONMENTS

- 144 IP-Rated Boxes
- 145 Outlet/Terminal Modules
- 146 Ruggedized Patch Cords
- 147 Coupler Modules
- 149 Ruggedized Field-Terminatable Plugs
- 150 DIN-Rail Products
- 152 Industrial Switches
- 153 SFP Transceivers



1.

COPPER

# CAT6A CABLES

CAT6A		
	UTP (Unshielded)	F/UTP (Overall Shield)
<b>CMP (Plenum)</b>	<b>ETL - USA</b> 176-300/A/P/BK 176-305/A/P/BL 176-310/A/P/GR 176-315/A/P/GY 176-320/A/P/OR 176-325/A/P/PK 176-330/A/P/PR 176-335/A/P/RD 176-340/A/P/WH 176-345/A/P/YL  <b>ETL</b> 065-700/A/P/BK 065-701/A/P/BL 065-702/A/P/GR 065-703/A/P/GY 065-705/A/P/PR 065-707/A/P/WH 065-708/A/P/YL	<b>ETL</b> 165-500/A/PS/BK 165-501/A/PS/BL 165-502/A/PS/GR 165-503/A/PS/GY 165-508/A/PS/WH 165-509/A/PS/YL
<b>CMR (Riser)</b>	<b>ETL</b> 064-484/A/BK 064-485/A/BL 064-486/A/WH 064-687/A/GR 064-688/A/GY 064-689/A/OR 064-691/A/PR 064-692/A/RD 064-693/A/YL	<b>ETL</b> 064-700/A/S/BK 064-701/A/S/BL 064-702/A/S/GR 064-703/A/S/GY 064-704/A/S/OR 064-706/A/S/PR 064-707/A/S/RD 064-708/A/S/WH 064-709/A/S/YL
<b>CM - 28 AWG Stranded (Slim)</b> Cordage (slim patch cords)	<b>UL</b> 173-200/ST/BK 173-201/ST/BL 173-208/ST/WH	N/A
<b>Outdoor (UV)</b>		
CMX	<b>ETL</b> 069-564/A/CMX	N/A
<b>Direct Burial</b>		
Dual jacket	N/A	<b>ETL</b> 069-565/A/CMXT

## CAT6A Plenum UTP

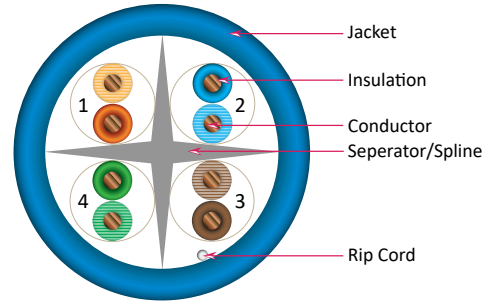

**Features:**

- Meets or exceeds ANSI/TIA-568.2-D
- Supports PoE Type 4 IEEE 802.3bt up to 90-100 W
- Supports IEEE 802.3 technologies up to 10 Gb/s (802.3an 10 GBASE-T)
- 23-AWG solid bare copper conductors
- Central spline and internally-ribbed jacket ensure excellent X-talk performance
- HDBase-T A & B

**Compatible with VC RJ45 plugs:**

012-021-100 | 012-025/EZF-100 | 012-026/EZF-100

Item #	Description
176-300/A/P/BK	CAT6A, PoE Type 4, 23 AWG, 4 Pair, 750 MHz, UTP, CMP, 1000 ft, Black
176-305/A/P/BL	CAT6A, PoE Type 4, 23 AWG, 4 Pair, 750 MHz, UTP, CMP, 1000 ft, Blue
176-310/A/P/GR	CAT6A, PoE Type 4, 23 AWG, 4 Pair, 750 MHz, UTP, CMP, 1000 ft, Green
176-315/A/P/GY	CAT6A, PoE Type 4, 23 AWG, 4 Pair, 750 MHz, UTP, CMP, 1000 ft, Gray
176-320/A/P/OR	CAT6A, PoE Type 4, 23 AWG, 4 Pair, 750 MHz, UTP, CMP, 1000 ft, Orange
176-325/A/P/PK	CAT6A, PoE Type 4, 23 AWG, 4 Pair, 750 MHz, UTP, CMP, 1000 ft, Pink
176-330/A/P/PR	CAT6A, PoE Type 4, 23 AWG, 4 Pair, 750 MHz, UTP, CMP, 1000 ft, Purple
176-335/A/P/RD	CAT6A, PoE Type 4, 23 AWG, 4 Pair, 750 MHz, UTP, CMP, 1000 ft, Red
176-340/A/P/WH	CAT6A, PoE Type 4, 23 AWG, 4 Pair, 750 MHz, UTP, CMP, 1000 ft, White
176-345/A/P/YL	CAT6A, PoE Type 4, 23 AWG, 4 Pair, 750 MHz, UTP, CMP, 1000 ft, Yellow



CAT6A Cable » CAT6A PLENUM

**CAT6A Plenum UTP - ETL**

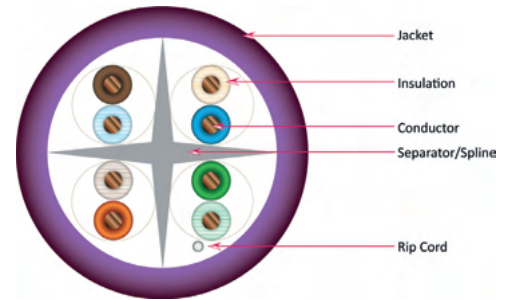

**Features:**

- Meets or exceeds ANSI/TIA-568.2-D
- Supports PoE Type 4 (IEEE 802.3bt) up to 100 W
- Supports IEEE 802.3 technologies up to 10 Gb/s (802.3an 10 GBASE-T)
- 23-AWG solid bare copper conductors
- Central spline and internally-ribbed jacket ensure excellent X-talk performance

**Compatible with VC RJ45 plugs:**

012-021-100 | 012-024/10G | 012-025/EZF-100  
012-026/EZF-100

Item #	Description
065-700/A/P/BK	CAT6A, PoE Type 4, 23 AWG, 4 Pair, 750 MHz, UTP, CMP, 1000 ft, Black
065-701/A/P/BL	CAT6A, PoE Type 4, 23 AWG, 4 Pair, 550 MHz, UTP, CMP, 1000 ft, Blue
065-702/A/P/GR	CAT6A, PoE Type 4, 23 AWG, 4 Pair, 550 MHz, UTP, CMP, 1000 ft, Green
065-703/A/P/GY	CAT6A, PoE Type 4, 23 AWG, 4 Pair, 550 MHz, UTP, CMP, 1000 ft, Gray
065-705/A/P/PR	CAT6A, PoE Type 4, 23 AWG, 4 Pair, 550 MHz, UTP, CMP, 1000 ft, Purple
065-707/A/P/WH	CAT6A, PoE Type 4, 23 AWG, 4 Pair, 550 MHz, UTP, CMP, 1000 ft, White

**CAT6A Plenum F/UTP (Overall Shield)**

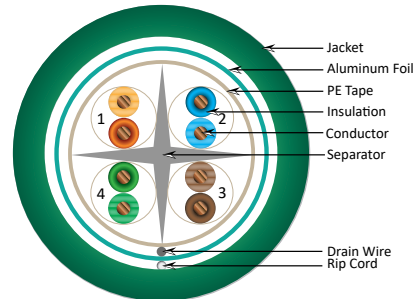

**Features:**

- Supports PoE Type 4 (IEEE 802.3bt) up to 100 W
- Exceeds ANSI/TIA-568.2-D and ISO/IEC 11801
- 23-AWG solid bare copper conductors
- ETL-Listed, RoHS-Compliant
- 1000 ft Wooden Spool

**Compatible with VC RJ45 plugs:**

012-021-100 | 012-024/10G | 012-026/EZF-100

Item #	Description
165-500/A/PS/BK	CAT6A, PoE Type 4, 23 AWG, 4 Pair, 750 MHz, UTP, CMP, 1000 ft, Black
165-501/A/PS/BL	CAT6A, PoE Type 4, 23 AWG, 4 Pair, 750 MHz, UTP, CMP, 1000 ft, Blue
165-502/A/PS/GR	CAT6A, PoE Type 4, 23 AWG, 4 Pair, 750 MHz, UTP, CMP, 1000 ft, Green
165-503/A/PS/GY	CAT6A, PoE Type 4, 23 AWG, 4 Pair, 750 MHz, UTP, CMP, 1000 ft, Gray
165-508/A/PS/WH	CAT6A, PoE Type 4, 23 AWG, 4 Pair, 750 MHz, UTP, CMP, 1000 ft, White
165-509/A/PS/YL	CAT6A, PoE Type 4, 23 AWG, 4 Pair, 750MHz, UTP, CMP, 1000 ft, Yellow

[CAT6A Patch Panels](#)

P64

## CAT6A Riser UTP (Unshielded)

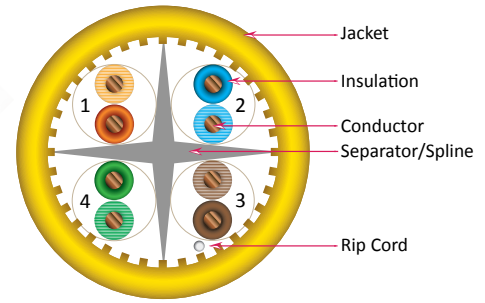

**Features:**

- Supports PoE Type 4 (IEEE 802.3bt) up to 100 W
- Exceeds ANSI/TIA-568.2-D and ISO/IEC 11801
- 23-AWG solid bare copper conductors
- ETL-listed, RoHS-Compliant
- 1000 ft Wooden Spool

**Compatible with VC RJ45 plugs:**  
 012-021-100 | 012-025/EZF-100 |  
 012-026/EZF-100

Item #	Description
064-484/A/BK	CAT6A, PoE Type 4, 750 MHz, UTP, CMR, 1000 ft, Spool, Black
064-485/A/BL	CAT6A, PoE Type 4, 750 MHz, UTP, CMR, 1000 ft, Spool, Blue
064-688/A/GY	CAT6A, PoE Type 4, 750 MHz, UTP, CMR, 1000 ft, Spool, Gray
064-687/A/GR	CAT6A, PoE Type 4, 750 MHz, UTP, CMR, 1000 ft, Spool, Green
064-692/A/RD	CAT6A, PoE Type 4, 750 MHz, UTP, CMR, 1000 ft, Spool, Red
064-486/A/WH	CAT6A, PoE Type 4, 750 MHz, UTP, CMR, 1000 ft, Spool, White
064-693/A/YL	CAT6A, PoE Type 4, 750 MHz, UTP, CMR, 1000 ft, Spool, Yellow
064-689/A/OR	CAT6A, PoE Type 4, 750 MHz, UTP, CMR, 1000 ft, Spool, Orange
064-695/A/RB/BL	CAT6A, PoE Type 4, 750 MHz, UTP, CMR, 1000 ft, Reel in a Box

## CAT6A Solid Riser F/UTP (Overall Shield)

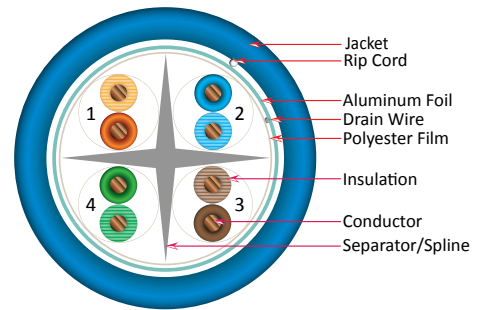
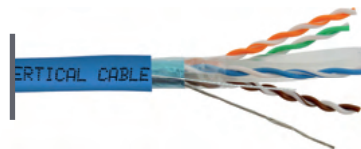

**Features:**

- Supports PoE Type 4 (IEEE 802.3bt) up to 100 W
- Exceeds ANSI/TIA-568.2-D and ISO/IEC 11801
- 23-AWG solid bare copper conductors
- ETL-listed, RoHS-Compliant
- 1000 ft Wooden Spool

**Compatible with VC RJ45 plugs:**  
 012-021-100 | 012-024/10G | 012-026/EZF-100

Item #	Description
064-700/A/S/BK	CAT6A, PoE Type 4, 750 MHz, F/UTP, CMR, 1000 ft, Spool, Black
064-701/A/S/BL	CAT6A, PoE Type 4, 750 MHz, F/UTP, CMR, 1000 ft, Spool, Blue
064-702/A/S/GR	CAT6A, PoE Type 4, 750 MHz, F/UTP, CMR, 1000 ft, Spool, Green
064-703/A/S/GY	CAT6A, PoE Type 4, 750 MHz, F/UTP, CMR, 1000 ft, Spool, Gray
064-707/A/S/RD	CAT6A, PoE Type 4, 750 MHz, F/UTP, CMR, 1000 ft, Spool, Red
064-704/A/S/OR	CAT6A, PoE Type 4, 750 MHz, F/UTP, CMR, 1000 ft, Spool, Orange
064-708/A/S/WH	CAT6A, PoE Type 4, 750 MHz, F/UTP, CMR, 1000 ft, Spool, White
064-709/A/S/YL	CAT6A, PoE Type 4, 750 MHz, F/UTP, CMR, 1000 ft, Spool, Yellow

CAT6A Slim Cable

**CAT6A Slim Stranded CM-Rated UTP (Unshielded)**

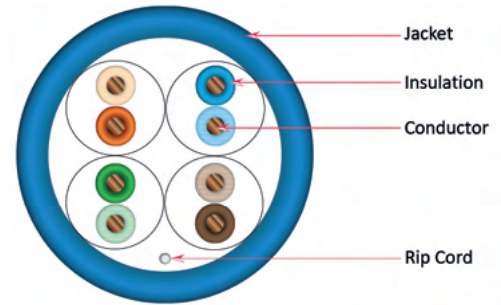

**Features:**

- Supports PoE Type 1 (IEEE 802.3af) up to 15.4 W
- 28-AWG stranded bare copper conductors
- RoHS-Compliant

**Compatible with VC RJ45 plugs:**  
012-027SLM-100

Item #	Description
173-200/ST/BK	CAT6A, PoE Type 1, Stranded, 1000 ft, Box, Black
173-201/ST/BL	CAT6A, PoE Type 1, Stranded, 1000 ft, Box, Blue
173-208/ST/WH	CAT6A, PoE Type 1, Stranded, 1000 ft, Box, White

**Need a specific length?  
Create custom-length  
patch cords on-site  
with ease.**

**Related products:**



012-027SLM-100  
Slim Modular Plug  
with a loading bar

017-067TR-100  
Slip-on Boot

P79

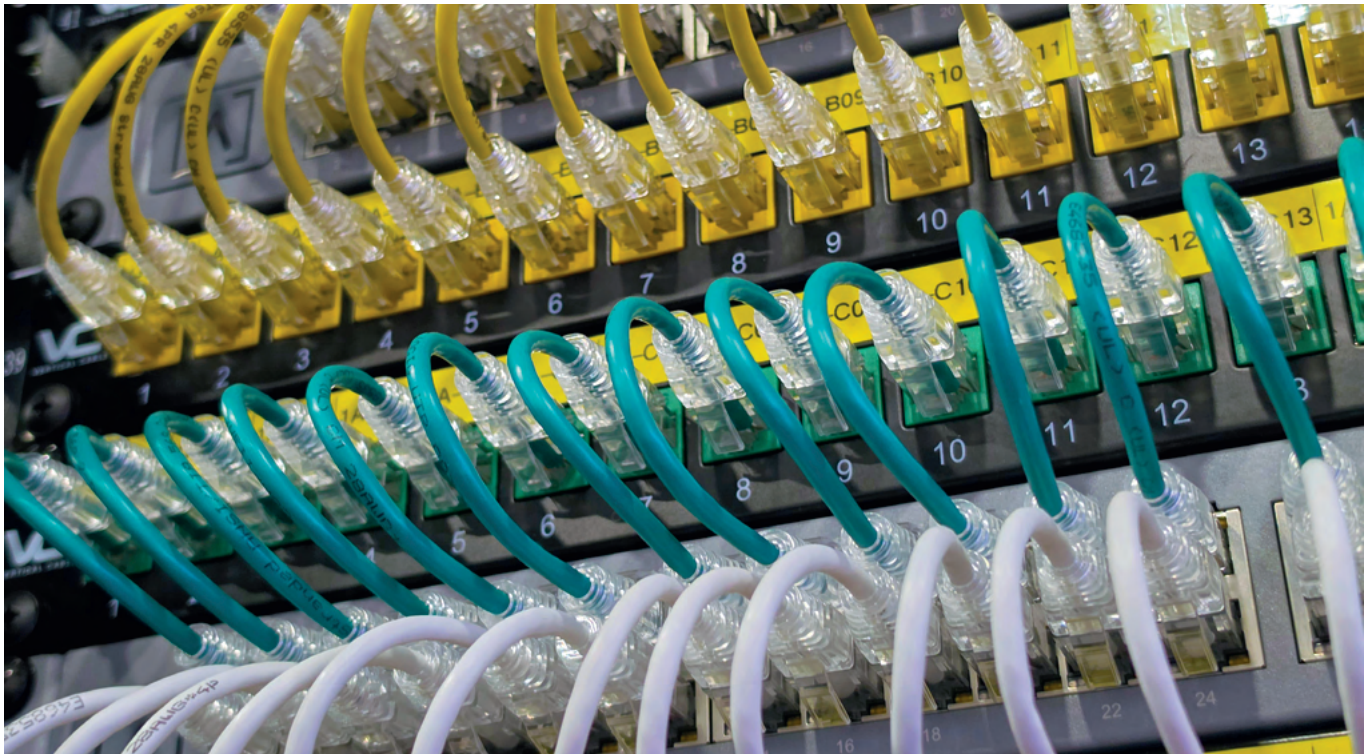

## CAT6A Outdoor-Rated - CMX

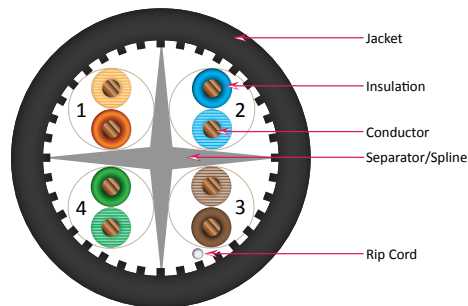

### Features:

- Supports PoE Type 4 (IEEE 802.3bt) up to 100 W
- Outdoor- and UV-Resistant Jacket Material
- For outdoor use above ground
- 23-AWG solid bare copper conductors
- Exceeds ANSI/TIA-568.2-D and ISO/IEC 11801
- Supports High-Speed Data Applications
- ETL-listed, RoHS-Compliant
- 1000 ft Wooden Spool

### Compatible with VC RJ45 plugs:

012-021-100 | 012-025-EZF-100 | 012-026-EZF-100

Item #	Description
069-564/A/CMX	CAT6A, PoE Type 4, 750MHz, Outdoor, CMX, 23 AWG, 4 Pair, UTP, 1000 ft, Spool, Black

[CAT6A Couplers IP68](#)

**P147**

## CAT6A Outdoor-Rated, Direct Burial - CMX (DUAL JACKET)

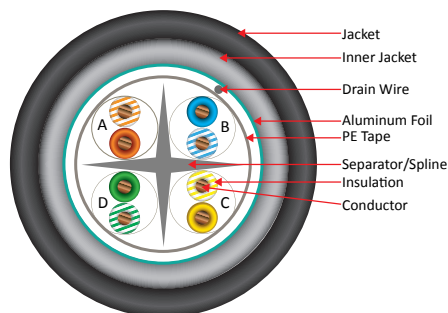

### Features:

- For outdoor use above ground and/or direct burial
- Supports PoE Type 4 (IEEE 802.3bt) up to 100 W
- Outdoor- and UV-Resistant Jacket Material
- 23-AWG solid bare copper conductors
- Exceeds ANSI/TIA-568.2-D and ISO/IEC 11801
- Supports High-Speed Data Applications including Ethernet 10 Gigabit
- ETL-listed, RoHS-Compliant
- 1000 ft Wooden Spool

### Compatible with VC RJ45 plugs:

012-021-100 | 012-024/10G | 012-026/EZF-100

Item #	Description
069-565/A/CMXT	CAT6A, PoE Type 4, 600 MHz. Direct Burial or Cell Tower Applications, CMXT, F/UTP - Shielded, Dual Jacket, 23 AWG, 4 Pair, 1000 ft, Spool, Black



**For a proper RJ45 plug fit, you must trim the outer jacket of the cable**



[CAT6A Ruggedized RJ45 Plugs](#)

**P149**

# CAT6 CABLE

<b>CAT6</b>			
	<b>UTP (Unshielded)</b>		<b>F/UTP (Overall Shield)</b>
<b>CMP</b>	<b>ETL - USA</b> 166-250/P/BK 166-251/P/BL 166-252/P/GR 166-253/P/GY 166-254/P/OR 166-255/P/PK 166-256/P/PR 166-257/P/RD 166-258/P/WH 166-259/P/YL <b>ETL</b> 066-990/P/BK 066-991/P/BL 066-992/P/GR 066-993/P/GY 066-994/P/OR 066-996/P/PR 066-998/P/WH 066-999/P/YL	N/A	<b>ETL</b> 168-400/S/P/BK 168-401/S/P/BL 168-402/S/P/GR 168-403/S/P/GY 168-406/S/P/PR 168-407/S/P/RD 168-408/S/P/WH 168-409/S/P/YL
<b>CMR</b>	<b>ETL</b> 060-2395/OR 060-487/BK 060-488/BL 060-489/GR 060-490/GY 060-491/PR 060-492/RD 060-493/WH 060-494/YL 060-495/PK <b>ETL - Splineless</b> 060-550/SL/BK 060-552/SL/BL 060-554/SL/GR 060-566/SL/WH 060-568/SL/YL	<b>UL</b> 060-610/U/BK 060-612/U/BL 060-614/U/GR 060-626/U/WH 060-628/U/YL	<b>ETL</b> 062-502/S/PR 062-503/S/BK 062-504/S/BL 062-505/S/GR 062-506/S/GY 062-507/S/OR 062-508/S/RD 062-509/S/WH 062-510/S/YL
<b>Outdoor (UV)</b>			
CMX	<b>ETL</b> 069-559/CMX 069-330/CMX - TAA-Compliant		N/A
with Messenger	<b>ETL</b> 069-562/MESG		<b>ETL</b> 069-563/S/MESG
<b>Direct Burial</b>			
Double jacket	<b>ETL</b> 069-557/US/CMXT		<b>ETL</b> 069-556/CMXT2K 069-561/CMXT
Gel-flooded core	<b>ETL</b> 069-560/CMXF		<b>ETL</b> 069-558/S/CMXF

## CAT6 UTP Plenum-Rated - Unshielded - ETL

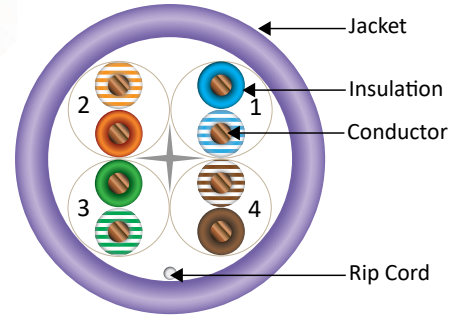

### Features:

- Supports PoE Type 3 (IEEE 802.3bt) up to 60 W
- Supports High-Speed Data Applications
- 23-AWG solid bare copper conductors
- Moisture-Resistant Box equipped with easy-to-pull tube
- Excellent Insertion Loss and Crosstalk Characteristics
- ETL-listed, RoHS-Compliant

**Compatible with VC RJ45 plugs:**  
012-021-100 | 012-022-100 | 012-023/EZF-100

Item #	Description
166-250/P/BK	CAT6 PoE Type 3, 550 MHz, 23 AWG, UTP, 1000 ft, Pullout Box, Black
166-251/P/BL	CAT6 PoE Type 3, 550 MHz, 23 AWG, UTP, 1000 ft, Pullout Box, Blue
166-252/P/GR	CAT6 PoE Type 3, 550 MHz, 23 AWG, UTP, 1000 ft, Pullout Box, Green
166-253/P/GY	CAT6 PoE Type 3, 550 MHz, 23 AWG, UTP, 1000 ft, Pullout Box, Gray
166-254/P/OR	CAT6 PoE Type 3, 550 MHz, 23 AWG, UTP, 1000 ft, Pullout Box, Orange
166-255/P/PK	CAT6 PoE Type 3, 550 MHz, 23 AWG, UTP, 1000 ft, Pullout Box, Pink
166-256/P/PR	CAT6 PoE Type 3, 550 MHz, 23 AWG, UTP, 1000 ft, Pullout Box, Purple
166-257/P/RD	CAT6 PoE Type 3, 550 MHz, 23 AWG, UTP, 1000 ft, Pullout Box, Red
166-258/P/WH	CAT6 PoE Type 3, 550 MHz, 23 AWG, UTP, 1000 ft, Pullout Box, White
166-259/P/YL	CAT6 PoE Type 3, 550 MHz, 23 AWG, UTP, 1000 ft, Pullout Box, Yellow

## CAT6 UTP Plenum-Rated - Unshielded - UL

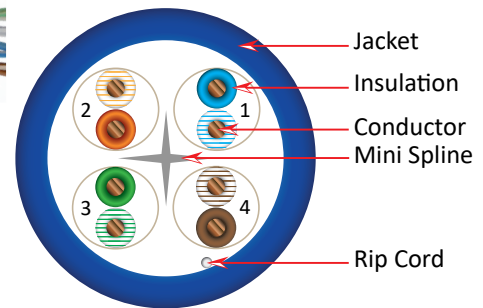

### Features:

- Supports PoE Type 3 (IEEE 802.3bt) up to 60 W
- Supports High-Speed Data Applications
- 23-AWG solid bare copper conductors
- Moisture-Resistant Box equipped with easy-to-pull tube
- Excellent Insertion Loss and Crosstalk Characteristics
- ETL-listed, RoHS-Compliant

Item #	Description
167-101/P/BL	CAT6 PoE Type 3, 550 MHz, 23 AWG, UTP, 1000 ft, Pullout Box, Blue
167-108/P/WH	CAT6 PoE Type 3, 550 MHz, 23 AWG, UTP, 1000 ft, Pullout Box, White

**Custom colors available upon request**

CAT6 Cable » CAT6 PLENUM

**CAT6 UTP Plenum-Rated - ETL**

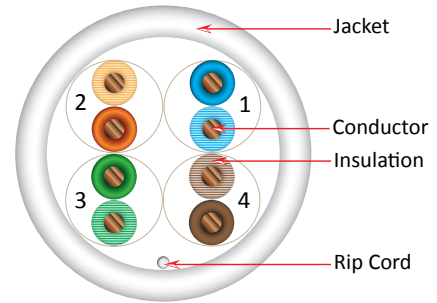
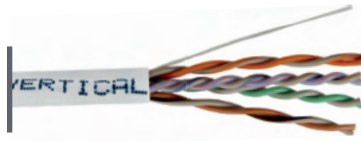

**Features:**

- o Splineless
- o Outer jacket LS-PVC
- o Supports PoE Type 3 (IEEE802.3bt) up to 60W
- o 23-AWG solid bare copper conductors
- o ETL-Listed, RoHS-Compliant

**Compatible with VC RJ45 plugs:**  
012-021-100 | 012-022-100 | 012-023/EZF-100

Item #	Description
066-990/P/BK	CAT6 PoE Type 3, 550 MHz Cable, 23 AWG, UTP, 1000 ft, Black - ETL
066-991/P/BL	CAT6 PoE Type 3, 550 MHz Cable, 23 AWG, UTP, 1000 ft, Blue - ETL
066-992/P/GR	CAT6 PoE Type 3, 550 MHz Cable, 23 AWG, UTP, 1000 ft, Green - ETL
066-993/P/GY	CAT6 PoE Type 3, 550 MHz Cable, 23 AWG, UTP, 1000 ft, Gray - ETL
066-994/P/OR	CAT6 PoE Type 3, 550 MHz Cable, 23 AWG, UTP, 1000 ft, Orange - ETL
066-996/P/PR	CAT6 PoE Type 3, 550 MHz Cable, 23 AWG, UTP, 1000 ft, Purple - ETL
066-998/P/WH	CAT6 PoE Type 3, 550 MHz Cable, 23 AWG, UTP, 1000 ft, White - ETL
066-999/P/YL	CAT6 PoE Type 3, 550 MHz Cable, 23 AWG, UTP, 1000 ft, Yellow - ETL

Plenum-Rated cable ties **P123**

**CAT6 F/UTP Plenum-Rated - Overall Shield**

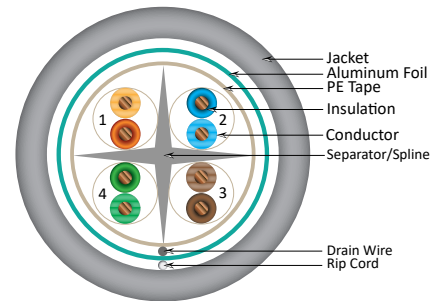

**Features:**

- o Supports PoE Type 4 (IEEE 802.3bt) up to 100 W
- o 23-AWG solid bare copper conductors
- o Exceeds ANSI/TIA-568.2-D and ISO/IEC 1180
- o ETL-listed, RoHS-Compliant
- o 1000 ft Wooden Spool

**Compatible with VC RJ45 plugs:**  
012-021-100 | 012-026/EZF-100

Item #	Description
168-400/S/P/BK	CAT6 PoE Type 4, 550 MHz 23 AWG, F/UTP 1000 ft, Black
168-401/S/P/BL	CAT6 PoE Type 4, 550 MHz 23 AWG, F/UTP 1000 ft, Blue
168-402/S/P/GR	CAT6 PoE Type 4, 550 MHz 23 AWG, F/UTP 1000 ft, Green
168-403/S/P/GY	CAT6 PoE Type 4, 550 MHz 23 AWG, F/UTP 1000 ft, Gray
168-408/S/P/WH	CAT6 PoE Type 4, 550 MHz 23 AWG, F/UTP 1000 ft, White
168-409/S/P/YL	CAT6 PoE Type 4, 550 MHz 23 AWG, F/UTP 1000 ft, Yellow

CAT6 Shielded Patch Panels **P65**

## CAT6 CMR UTP Riser-Rated

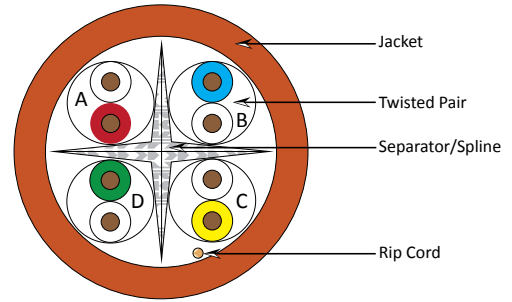
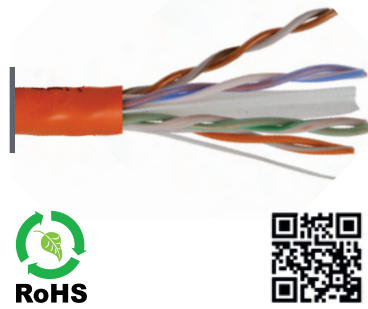

### Features:

- Supports PoE Type 4 (IEEE 802.3bt) up to 100 W
- 23-AWG solid bare copper conductors
- Exceeds ANSI/TIA-568.2-D and ISO/IEC 11801
- RoHS-Compliant
- 1000 ft Box

**Compatible with VC RJ45 plugs:**  
012-022-100 | 012-023/EZF-100

Item #	Description
060-610/U/BK	CAT6 PoE Type 4, 550 MHz, 23 AWG, UTP, 1000 ft, Black
060-612/U/BL	CAT6 PoE Type 4, 550 MHz, 23 AWG, UTP, 1000 ft, Blue
060-614/U/GR	CAT6 PoE Type 4, 550 MHz, 23 AWG, UTP, 1000 ft, Green
060-626/U/WH	CAT6 PoE Type 4, 550 MHz, 23 AWG, UTP, 1000 ft, Gray
060-628/U/YL	CAT6 PoE Type 4, 550 MHz, 23 AWG, UTP, 1000 ft, Orange

[CAT6 Modular Plugs](#)

[P78](#)

## CAT6 CMR UTP Riser-Rated - ETL

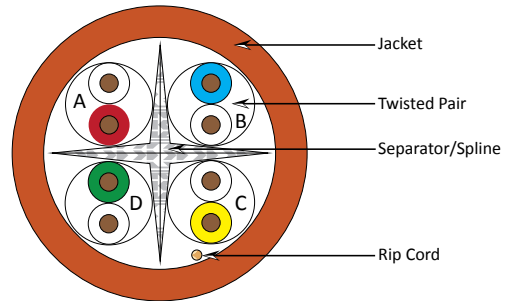
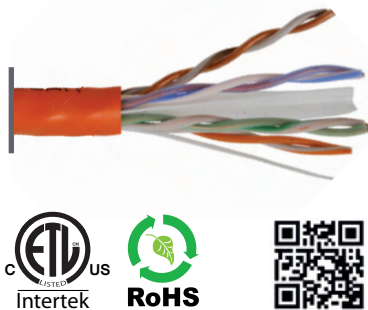

### Features:

- Supports PoE Type 4 (IEEE 802.3bt) up to 100 W
- 23-AWG solid bare copper conductors
- Exceeds ANSI/TIA-568.2-D and ISO/IEC 11801
- ETL-listed, RoHS-Compliant
- 1000 ft Box

**Compatible with VC RJ45 plugs:**  
012-022-100 | 012-023/EZF-100

Item #	Description
060-487/BK	CAT6 PoE Type 4, 550 MHz, 23 AWG, UTP, 1000 ft, ETL, Black
060-488/BL	CAT6 PoE Type 4, 550 MHz, 23 AWG, UTP, 1000 ft, ETL, Blue
060-489/GR	CAT6 PoE Type 4, 550 MHz, 23 AWG, UTP, 1000 ft, ETL, Green
060-490/GY	CAT6 PoE Type 4, 550 MHz, 23 AWG, UTP, 1000 ft, ETL, Gray
060-2395/OR	CAT6 PoE Type 4, 550 MHz, 23 AWG, UTP, 1000 ft, ETL, Orange
060-495/PK	CAT6 PoE Type 4, 550 MHz, 23 AWG, UTP, 1000 ft, ETL, Pink
060-491/PR	CAT6 PoE Type 4, 550 MHz, 23 AWG, UTP, 1000 ft, ETL, Purple
060-492/RD	CAT6 PoE Type 4, 550 MHz, 23 AWG, UTP, 1000 ft, ETL, Red
060-493/WH	CAT6 PoE Type 4, 550 MHz, 23 AWG, UTP, 1000 ft, ETL, White
060-494/YL	CAT6 PoE Type 4, 550 MHz, 23 AWG, UTP, 1000 ft, ETL, Yellow

CAT6 Cable » CAT6 RISER

**CAT6 CMR UTP Riser-Rated - ETL - Splinesless**

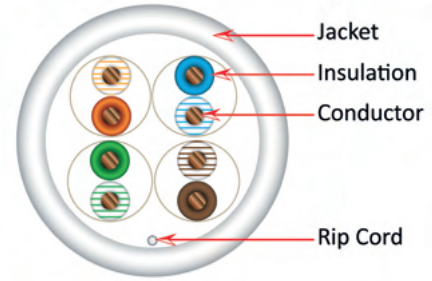

**Features:**

- o Splinesless
- o Supports PoE Type 4 (IEEE 802.3bt) up to 100 W
- o 23-AWG solid bare copper conductors
- o Exceeds ANSI/TIA-568.2-D and ISO/IEC 11801
- o ETL-listed, RoHS-Compliant
- o 1000 ft Box

**Compatible with VC RJ45 plugs:**  
012-022-100 | 012-023/EZF-100

Item #	Description
060-550/SL/BK	CAT6 PoE Type 4, 550 MHz, 23 AWG, UTP, 1000 ft, ETL, Black
060-552/SL/BL	CAT6 PoE Type 4, 550 MHz, 23 AWG, UTP, 1000 ft, ETL, Blue
060-554/SL/GR	CAT6 PoE Type 4, 550 MHz, 23 AWG, UTP, 1000 ft, ETL, Green
060-566/SL/WH	CAT6 PoE Type 4, 550 MHz, 23 AWG, UTP, 1000 ft, ETL, White
060-568/SL/YL	CAT6 PoE Type 4, 550 MHz, 23 AWG, UTP, 1000 ft, ETL, Yellow

**CAT6 CMR F/UTP Riser-Rated - Overall Shield**

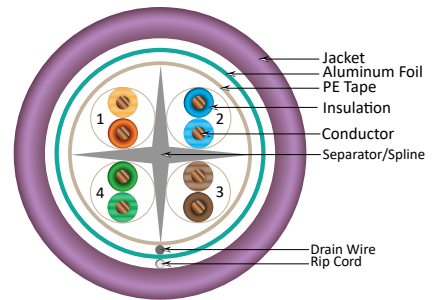

**Features:**

- o Supports PoE Type 3 (IEEE 802.3bt) up to 60 W
- o 23-AWG solid bare copper conductors
- o Easy-to-See Vivid-Color Conductor Insulation
- o Exceeds ANSI/TIA-568.2-D and ISO/IEC 11801
- o ETL-listed, RoHS-Compliant
- o 1000 ft Wooden Spool

**Compatible with VC RJ45 plugs:**  
012-021-100 | 012-026/EZF-100

Item #	Description
062-503/S/BK	CAT6 PoE Type 3, 550 MHz, 23 AWG, F/UTP, 1000 ft, Black
062-504/S/BL	CAT6 PoE Type 3, 550 MHz, 23 AWG, F/UTP, 1000 ft, Blue
062-505/S/GR	CAT6 PoE Type 3, 550 MHz, 23 AWG, F/UTP, 1000 ft, Gray
062-506/S/GY	CAT6 PoE Type 3, 550 MHz, 23 AWG, F/UTP, 1000 ft, Green
062-507/S/OR	CAT6 PoE Type 3, 550 MHz, 23 AWG, F/UTP, 1000 ft, Orange
062-502/S/PR	CAT6 PoE Type 3, 550 MHz, 23 AWG, F/UTP, 1000 ft, Purple
062-508/S/RD	CAT6 PoE Type 3, 550 MHz, 23 AWG, F/UTP, 1000 ft, Red
062-509/S/WH	CAT6 PoE Type 3, 550 MHz, 23 AWG, F/UTP, 1000 ft, White
062-510/S/YL	CAT6 PoE Type 3, 550 MHz, 23 AWG, F/UTP, 1000 ft, Yellow

# CAT6 Outdoor-Rated, CMX

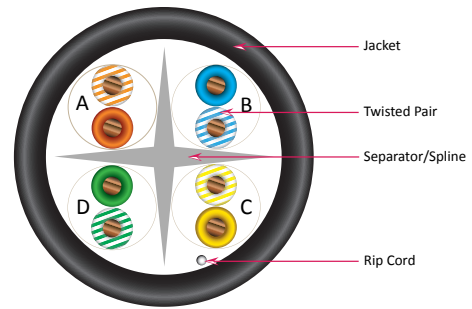
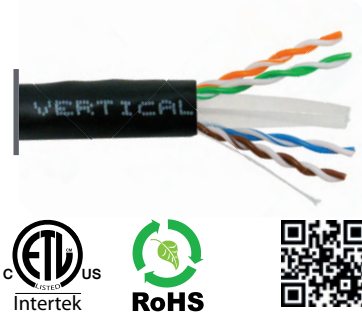

### Features:

- Supports PoE Type 4 (IEEE 802.3bt) up to 100 W
- Unshielded Twisted-Pair (UTP) Construction
- Easily Identified Color-Striped Pairs
- 23-AWG solid bare copper conductors
- Exceeds ANSI/TIA-568.2-D and ISO/IEC 11801
- Outdoor- and UV-Resistant Jacket Material
- ETL-listed, RoHS-Compliant
- 1000 ft Wooden Spool

### Compatible with VC RJ45 plugs:

012-021-100 | 012-022-100 | 012-023/EZF-100  
012-025/EZF-100 | 012-026/EZF-100

Item #	Description
069-330/CMX	CAT6 PoE Type 4, 550 MHz, Outdoor Jacket, UV-Rated Jacket, CMX-Rated, 1000 ft, Black - TAA-Compliant
069-559/CMX	CAT6 PoE Type 4, 550 MHz, Outdoor Jacket, UV-Rated Jacket, CMX-Rated, 1000 ft, Black

# CAT6 Outdoor-Rated With Messenger

Aerial Applications - Unshielded & Shielded

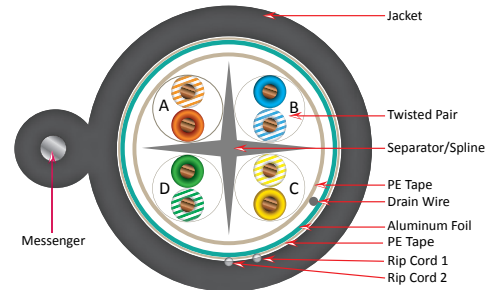
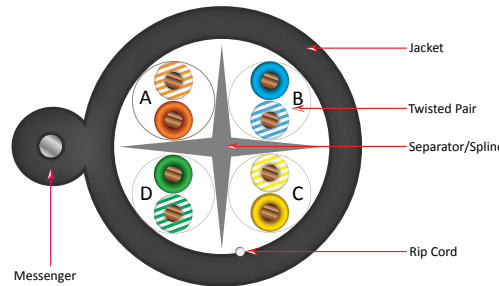
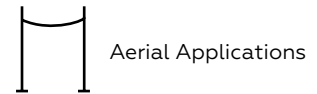

### Features:

- Supports PoE Type 4 (IEEE 802.3bt) up to 100 W
- Galvanized Steel Messenger
- 23-AWG solid bare copper conductors
- Exceeds ANSI/TIA-568.2-D and ISO/IEC 11801
- Outdoor- and UV-Resistant Jacket Material
- ETL-listed, RoHS-Compliant
- 1000 ft Wooden Spool

### Compatible with VC RJ45 plugs:

012-021-100 | 012-022-100 | 012-023/EZF-100  
012-025/EZF-100 | 012-026/EZF-100

Item #	Description
069-562/MESG	CAT6 PoE Type 4, 550 MHz, UTP <b>Unshielded</b> , Outdoor-Rated with Messenger, Aerial Applications, LLDPE Jacket, 23 AWG, Solid Bare Copper, 1000 ft, Spool, Black
069-563/S/MESG	CAT6 PoE Type 4, 550 MHz, F/UTP <b>Shielded</b> , Outdoor-Rated with Messenger, Aerial Applications, LLDPE Jacket, 23 AWG, Solid Bare Copper, 1000 ft, Black



CAT6 Cable » CAT6 DIRECT BURIAL

**CAT6 Direct Burial, CMX (DOUBLE JACKET)**

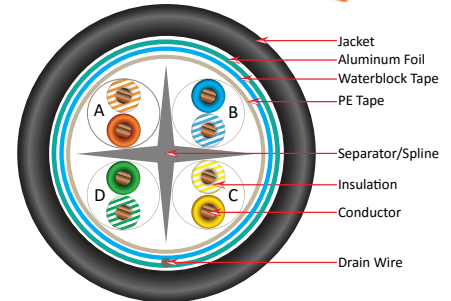
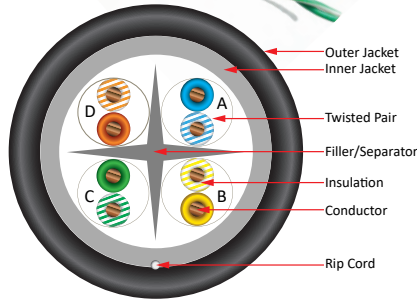

Features:

- Supports PoE Type 4 (IEEE 802.3bt) up to 100 W
- 23-AWG solid bare copper conductors
- Outdoor- and UV-Resistant Jacket Material
- Exceeds ANSI/TIA-568.2-D and ISO/IEC 11801
- ETL-listed, RoHS-Compliant
- 1000 ft Spool

**Compatible with VC RJ45 plugs:**  
 012-021-100 | 012-022-100 | 012-023/EZF-100  
 012-025/EZF-100 | 012-026/EZF-100

Item #	Description
069-557/US/CMXT	CAT6 PoE Type 4, 550 MHz, CMX Direct Burial, UTP <b>Unshielded</b> , Double Jacket, LLDPE Jacket, 23 AWG, Solid, 1000 ft, Black
069-556/CMXT2K	CAT6 PoE Type 4, 550 MHz, CMX, Direct Burial, LLDPE Jacket, F/UTP <b>Shielded</b> , 23 AWG, Double Jacket, 2000 ft, Black
069-561/CMXT	CAT6 PoE Type 4, 550 MHz, CMX, Direct Burial, LLDPE Jacket, F/UTP <b>Shielded</b> , 23 AWG, Double Jacket, 1000 ft, Black



**For a proper RJ45 plug fit, you must trim the outer jacket of the cable**



**CAT6 Direct Burial, CMX (GEL-FLOODED CORE) Unshielded & Shielded**

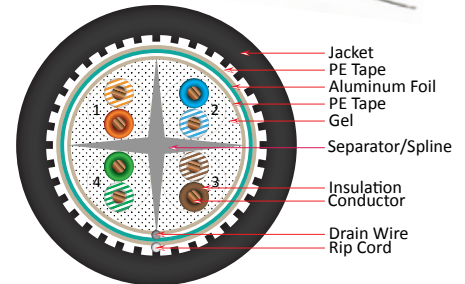
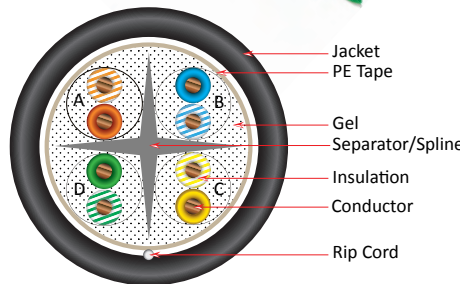

Features:

- Supports PoE Type 4 (IEEE 802.3bt) up to 100 W
- 23-AWG solid bare copper conductors
- Outdoor- and UV-Resistant Jacket Material
- Exceeds ANSI/TIA-568.2-D and ISO/IEC 11801
- ETL-listed, RoHS-Compliant
- 1000 ft Spool

**Compatible with VC RJ45 plugs:**  
 012-021-100 | 012-022-100 | 012-023/EZF-100  
 012-025/EZF-100 | 012-026/EZF-100

Item #	Description
069-560/CMXF	CAT6 PoE Type 4, 550 MHz, CMXF Direct Burial, Gel-Flooded Core, <b>Unshielded</b> , 23 AWG, Solid, Black
069-558/S/CMXF	CAT6 PoE Type 4, 550 MHz, CMXF Direct Burial, Gel-Flooded Core, <b>Shielded</b> , Drain Wire, 23 AWG, Black



## Powering Commercial & Residential Installations

We are proud that VC products are trusted in hospitals, schools, stadiums, industrial facilities, and homes of every size — from condominiums to luxury residences.

ACCESS CONTROL



DATA CABLE



FIBER



AUDIO



SECURITY



COAX



FIRE ALARM



THERMOSTAT



LED



# CAT5E CABLE

<b>CAT5E</b>		
	<b>UTP (Unshielded)</b>	<b>F/UTP (Shielded)</b>
<b>CMP (Plenum)</b>	<b>ETL</b> 055-452/P/BK 055-453/P/BL 055-454/P/GR 055-455/P/GY 055-456/P/PR 055-457/P/RD 055-458/P/WH 055-459/P/YL 055-460/P/OR 055-461/P/PK	<b>ETL</b> 057-905/S/P/BL
<b>CMR (Riser)</b>	<b>ETL</b> 054-444BK 054-445BL 054-446GR 054-447GY 054-448PR 054-449RD 054-450WH 054-451YL 054-2392OR	<b>ETL</b> 057-468/S/BK 057-469/S/BL 057-470/S/GR 057-471/S/GY 057-472/S/PR 057-473/S/RD 057-474/S/WH 057-475/S/YL 057-476/S/OR
<b>Backbone Cable (non-plenum)</b>	<b>ETL 25-pair</b> 054-452WH 054-453GY 054-454BL <b>ETL 50-pair</b> 054-455/BL	N/A
<b>Outdoor (UV Jacket)</b>		
CMX	<b>ETL</b> 059-484/CMX 059-484/CMX/WH 059-484/CMX/GY 059-488/WS/CMX 059-491/CMX2K	N/A
with Messenger	<b>ETL</b> 059-497/MESG	<b>ETL</b> 059-498/S/MESG
<b>Direct Burial</b>		
CMX - Double jacket	<b>ETL</b> 059-486/US/CMXT	<b>ETL</b> 059-486/CMXT 059-490/WS/CMXT 059-493/CMXT2K
CMX - Gel-flooded core	<b>ETL</b> 059-485/CMXF 059-489/WS/CMXF 059-488/CMXF25P (25-pair)	<b>ETL</b> 059-487/S/CMXF
CMX - Cell Towers	N/A	<b>ETL</b> 059-494/WS/CWT 059-494/RB/CWT 059-495/S1/CWT 059-496/S2/CWT

## CAT5E CMP Plenum UTP - Unshielded

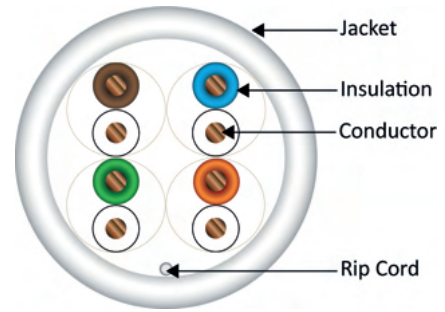





### Features:

- Supports PoE Type 3 (IEEE 802.3bt) up to 60 W
- 24-AWG solid bare copper conductors
- Moisture-Resistant Box equipped with easy-to-pull tube
- Supports High-Speed Data Applications up to 1 Gbps
- ETL-listed, RoHS-Compliant
- 1000 ft Pull Box

**Compatible with VC RJ45 plugs:**  
011-016-100 | 011-018/EZF-100

Item #	Description
055-452/P/BK	CAT5E PoE Type 3, 350 MHz, CMP, UTP, 1000 ft, Black
055-453/P/BL	CAT5E PoE Type 3, 350 MHz, CMP, UTP, 1000 ft, Blue
055-454/P/GR	CAT5E PoE Type 3, 350 MHz, CMP, UTP, 1000 ft, Green
055-455/P/GY	CAT5E PoE Type 3, 350 MHz, CMP, UTP, 1000 ft, Gray
055-456/P/PR	CAT5E PoE Type 3, 350 MHz, CMP, UTP, 1000 ft, Purple
055-457/P/RD	CAT5E PoE Type 3, 350 MHz, CMP, UTP, 1000 ft, Red
055-458/P/WH	CAT5E PoE Type 3, 350 MHz, CMP, UTP, 1000 ft, White
055-459/P/YL	CAT5E PoE Type 3, 350 MHz, CMP, UTP, 1000 ft, Yellow
055-460/P/OR	CAT5E PoE Type 3, 350 MHz, CMP, UTP, 1000 ft, Orange
055-461/P/PK	CAT5E PoE Type 3, 350 MHz, CMP, UTP, 1000 ft, Pink

### Related products:

<p>043 Series</p>  <p><a href="#">Blank Patch Panels</a> <span style="border: 1px solid black; padding: 2px;">P66</span></p>	<p>351 Series</p>  <p><a href="#">V-Max Keystone Jacks</a> <span style="border: 1px solid black; padding: 2px;">P31</span></p>	<p>092 Series</p>  <p><a href="#">CAT5E Patch Cords</a> <span style="border: 1px solid black; padding: 2px;">P75</span></p>
<p>045-V34/75BK</p>  <p><a href="#">Hook and Loop Tie Wrap</a> <span style="border: 1px solid black; padding: 2px;">P123</span></p>	<p>041 Series</p>  <p><a href="#">CAT5E Patch Panels</a> <span style="border: 1px solid black; padding: 2px;">P64</span></p>	<p>040-371/C5J/WH</p>  <p><a href="#">CAT5E Junction Boxes</a> <span style="border: 1px solid black; padding: 2px;">P57</span></p>

CAT5E Cable » CAT5E RISER

**CAT5E CMR Riser UTP - Unshielded**

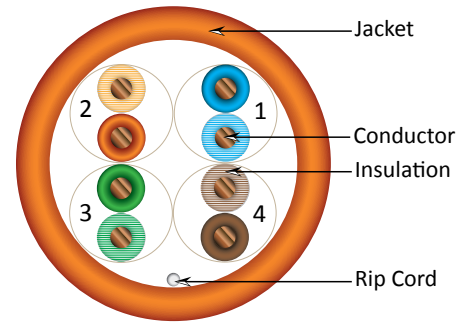

**Features:**

- Supports PoE Type 1 (IEEE 802.3af) up to 15.4 W
- 24-AWG solid bare copper conductors
- Supports High-Speed Data Applications up to 1 Gbps
- ETL-listed, RoHS-Compliant
- 1000 ft Pull Box

**Compatible with VC RJ45 plugs:**  
011-016-100 | 011-018/EZF-100

Item #	Description
054-444BK	CAT5E PoE Type 1, 350 MHz, CMR, UTP, 1000 ft, Black
054-445BL	CAT5E PoE Type 1, 350 MHz, CMR, UTP, 1000 ft, Blue
054-446GR	CAT5E PoE Type 1, 350 MHz, CMR, UTP, 1000 ft, Green
054-447GY	CAT5E PoE Type 1, 350 MHz, CMR, UTP, 1000 ft, Gray
054-448PR	CAT5E PoE Type 1, 350 MHz, CMR, UTP, 1000 ft, Purple
054-449RD	CAT5E PoE Type 1, 350 MHz, CMR, UTP, 1000 ft, Red
054-2392OR	CAT5E PoE Type 1, 350 MHz, CMR, UTP, 1000 ft, Orange
054-450WH	CAT5E PoE Type 1, 350 MHz, CMR, UTP, 1000 ft, White
054-451YL	CAT5E PoE Type 1, 350 MHz, CMR, UTP, 1000 ft, Yellow

**CAT5E CMR Riser F/UTP - Overall Shield**

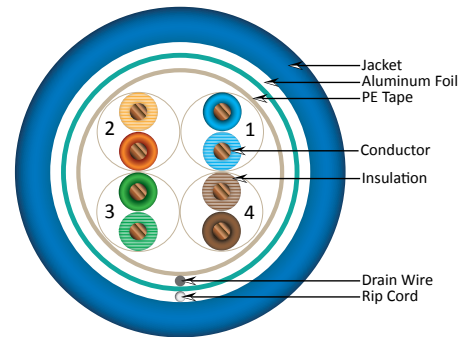

**Features:**

- Supports PoE Type 3 (IEEE 802.3bt) up to 60 W
- 24-AWG solid bare copper conductors
- Moisture-Resistant Box equipped with easy-to-pull tube
- Supports High-Speed Data Applications up to 1 Gbps
- ETL-listed, RoHS-Compliant
- 1000 ft Pull Box

**Compatible with VC RJ45 plugs:**  
011-017-100 | 011-019/EZF-100 | 011-020G-100

Item #	Description
057-468/S/BK	CAT5E PoE Type 3, 350 MHz, F/UTP, 1000 ft, Black
057-469/S/BL	CAT5E PoE Type 3, 350 MHz, F/UTP, 1000 ft, Blue
057-470/S/GR	CAT5E PoE Type 3, 350 MHz, F/UTP, 1000 ft, Green
057-471/S/GY	CAT5E PoE Type 3, 350 MHz, F/UTP, 1000 ft, Gray
057-476/S/OR	CAT5E PoE Type 3, 350 MHz, F/UTP, 1000 ft, Orange
057-472/S/PR	CAT5E PoE Type 3, 350 MHz, F/UTP, 1000 ft, Purple
057-473/S/RD	CAT5E PoE Type 3, 350 MHz, F/UTP, 1000 ft, Red
057-474/S/WH	CAT5E PoE Type 3, 350 MHz, F/UTP, 1000 ft, White
057-475/S/YL	CAT5E PoE Type 3, 350 MHz, F/UTP, 1000 ft, Yellow

## CAT5E 25 Pair Power Sum UTP - Unshielded

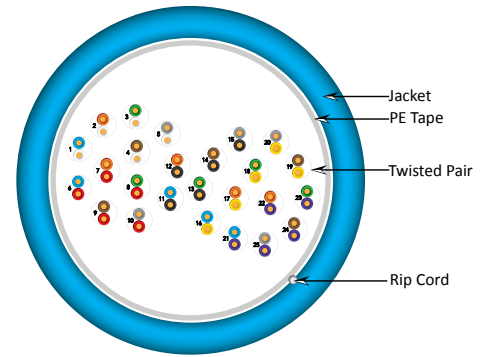
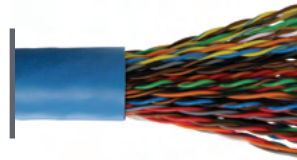

**Features:**

- Supports PoE Type 3 (IEEE 802.3bt) up to 60 W
- 24-AWG solid bare copper conductors
- Exceeds ANSI/TIA-568.2-D and ISO/IEC 11801
- ETL-listed, RoHS-Compliant
- 1000 ft Wooden Spool

Item #	Description
054-454BL	CAT5E PoE Type 3, 350 MHz, 25 Pair Power Sum, 24 AWG, Blue
054-453GY	CAT5E PoE Type 3, 350 MHz, 25 Pair Power Sum, 24 AWG, Gray
054-452WH	CAT5E PoE Type 3, 350 MHz, 25 Pair Power Sum, 24 AWG, White

[CAT5E Direct Burial Cable, 25-Pair](#)

**P29**

## CAT5E 50 Pair Power Sum UTP - Unshielded

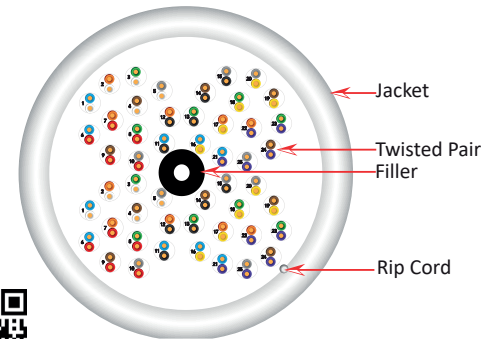
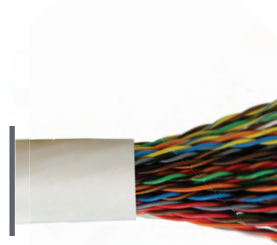
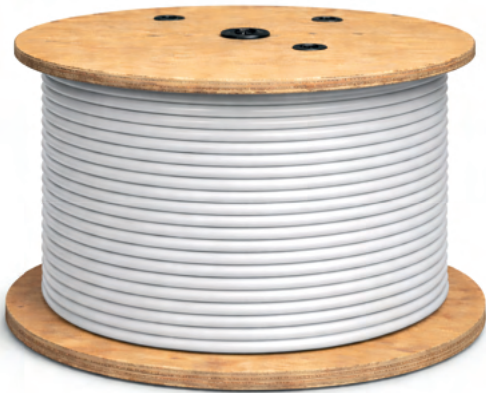

**Features:**

- Supports PoE Type 3 (IEEE 802.3bt) up to 60 W
- 24-AWG solid bare copper conductors
- Exceeds ANSI/TIA-568.2-D and ISO/IEC 11801
- ETL-listed, RoHS-Compliant
- 1000 ft Wooden Spool

Item #	Description
054-455/BL	CAT5E PoE Type 3, 350 MHz, 50 Pair Power Sum, 24 AWG, Blue
054-456/WH	CAT5E PoE Type 3, 350 MHz, 50 Pair Power Sum, 24 AWG, White



# Four Stocking Locations

# CAT5E Outdoor Cable, CMX - UTP - Unshielded



059-484/CMX

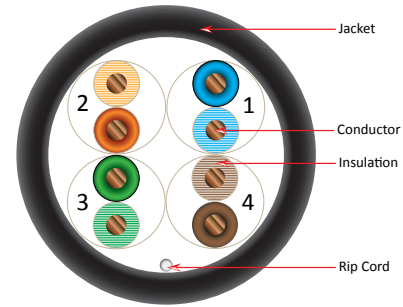

**Features:**

- o Outdoor- and UV-Resistant Jacket Material
- o Supports PoE Type 3 (IEEE 802.3bt) up to 60 W
- o 24-AWG solid bare copper conductors
- o Exceeds ANSI/TIA-568.2-D and ISO/IEC 11801
- o ETL-listed, RoHS-Compliant
- o 1000 ft Pull Box or 2000 ft Wooden Spool

**Compatible with VC RJ45 plugs:**

011-016-100 | 011-018/EZF-100

Item #	Description
059-484/CMX	CAT5E PoE Type 3, 350 MHz, UV Jacket, UTP CMX, 1000 ft, Black
059-484/CMX/GY	CAT5E PoE Type 3, 350 MHz, UV Jacket, UTP CMX, 1000 ft, Gray
059-484/CMX/WH	CAT5E PoE Type 3, 350 MHz, UV Jacket, UTP CMX, 1000 ft, White
059-488/WS/CMX	CAT5E PoE Type 3, 350 MHz, UV Jacket, UTP CMX, 1000 ft, Spool, Black
059-491/CMX2K	CAT5E PoE Type 3, 350 MHz, UV Jacket, UTP CMX, 2000 ft, Spool, Black

# CAT5E Outdoor Cable, Cell Tower Applications



Cell Tower Applications



059-494/WS/CWT



059-495/S1/CWT

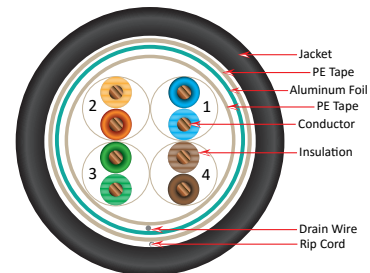
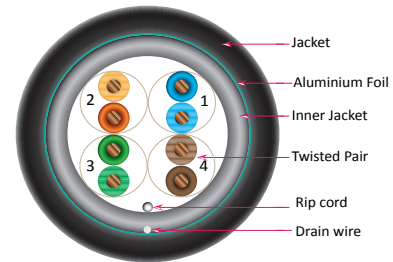

**Features:**

- o Supports PoE Type 3 (IEEE 802.3bt) up to 60 W
- o Outdoor- and UV-Resistant Jacket Material
- o 24-AWG solid bare copper conductors
- o Exceeds ANSI/TIA-568.2-D and ISO/IEC 11801
- o ETL-listed, RoHS-Compliant
- o 1000 ft Wooden Spool

**Compatible with VC RJ45 plugs:**

011-017-100 | 011-019/EZF-100 | 011-020G-100

Item #	Description
059-494/WS/CWT	CAT5E PoE Type 3, 350 MHz, Cell Tower Outdoor or Direct Burial, Shielded, Dual Jacket, 1000 ft, Spool, Black
059-494/RB/CWT	CAT5E PoE Type 3, 350 MHz, Cell Tower Outdoor or Direct Burial, Shielded, Dual Jacket, 1000 ft Reel-in-Box, Black
059-495/S1/CWT	CAT5E PoE Type 3, 350 MHz, Cell Tower Outdoor, Shielded, Drain Wire, 1000 ft, Spool, Black
059-496/S2/CWT	CAT5E PoE Type 3, 350 MHz, Cell Tower Outdoor, Shielded, 95% TC Braid, 1000 ft Spool, Black

CAT5E Cable » CAT5E OUTDOOR

**CAT5E Outdoor Cable with Messenger for Aerial Applications**



059-497/MESG

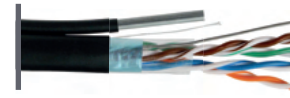

059-498/S/MESG

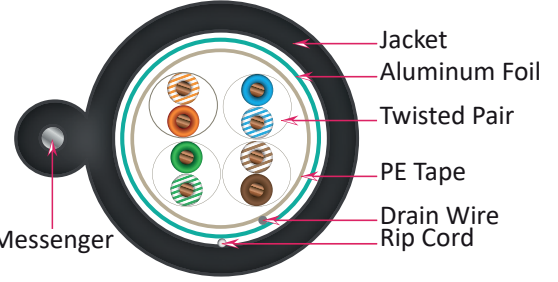
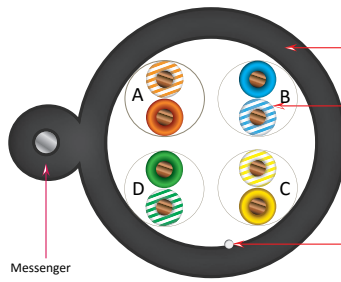

**Features:**

- Supports PoE Type 3 (IEEE 802.3bt) up to 60 W
- Galvanized Steel Messenger for Support
- Outdoor and UV-Resistant Jacket Material
- 24-AWG solid bare copper conductors
- Exceeds ANSI/TIA-568.2-D and ISO/IEC 11801
- ETL-listed, RoHS-Compliant
- 1000 ft Wooden Spool

**Compatible with VC RJ45 plugs:**

011-016-100 | 011-017-100 | 011-018/EZF-100  
011-019/EZF-100 | 011-020G-100

Item #	Description
--------	-------------

059-497/MESG	CAT5E PoE Type 3, 350 MHz, UTP <b>Unshielded</b> , Outdoor-Rated Cable with Messenger, Aerial Applications, 24 AWG, 1000 ft, Wooden Spool, Black
--------------	--

059-498/S/MESG	CAT5E PoE Type 3, 350 MHz, F/UTP <b>Shielded</b> , Outdoor-Rated Cable with Messenger, Aerial Applications, 24 AWG, 1000 ft, Wooden Spool, Black
----------------	--



Aerial Applications



048-301/TC

P116

**CAT5E Direct Burial, CMX (DUAL JACKET) - UTP & F/UTP**



059-486/US/CMXT

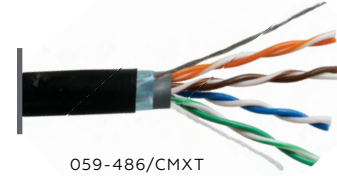

059-486/CMXT

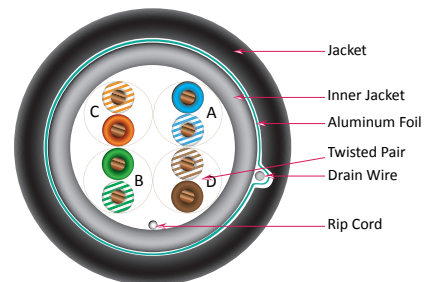
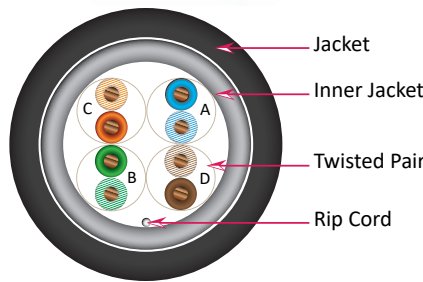

**Features:**

- Supports PoE Type 3 (IEEE 802.3bt) up to 60 W
- Outdoor and UV-Resistant Jacket Material
- 24-AWG solid bare copper conductors
- Exceeds ANSI/TIA-568.2-D and ISO/IEC 11801
- ETL-listed, RoHS-Compliant
- 1000 ft Pull Box or Wooden Spool

**Compatible with VC RJ45 plugs:**

011-017-100 | 011-019/EZF-100

Item #	Description
--------	-------------

059-486/US/CMXT	CAT5E PoE Type 3, 350 MHz, Direct Burial, <b>Unshielded</b> , Dual Jacket, Water-Resistant, LSZH Outer Jacket, 1000 ft Pull Box, Black
-----------------	--

059-486/CMXT	CAT5E PoE Type 3, 350 MHz, Direct Burial, <b>Shielded</b> , Dual Jacket, Water-Resistant, LSZH Outer Jacket, 1000 ft Pull Box, Black
--------------	--

059-490/WS/CMXT	CAT5E PoE Type 3, 350 MHz, Direct Burial, <b>Shielded</b> , Dual Jacket, Water-Resistant, LSZH Outer Jacket, <b>1000 ft</b> Spool, Black
-----------------	--

059-493/CMXT2K	CAT5E PoE Type 3, 350 MHz, Direct Burial, <b>Shielded</b> , Dual Jacket, Water-Resistant, LSZH Outer Jacket, <b>2000 ft</b> Spool, Black
----------------	--

# CAT5E Direct Burial, CMX (GEL-FLOODED CORE) - UTP, F/UTP

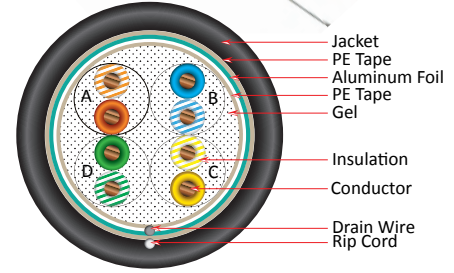
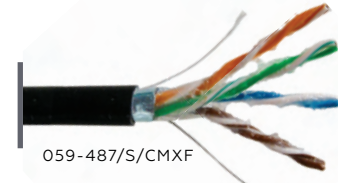
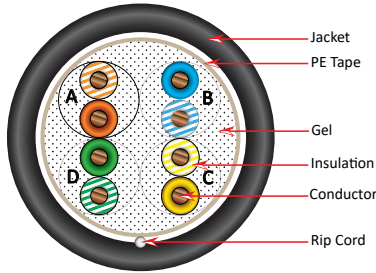
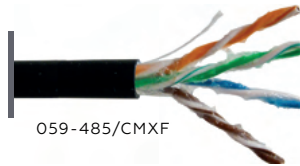

**Features:**

- Supports PoE Type 3 (IEEE 802.3bt) up to 60 W
- Gel-Flooded Core
- Outdoor and UV-Resistant Jacket Material
- 24-AWG solid bare copper conductors
- Exceeds ANSI/TIA-568.2-D and ISO/IEC 11801
- ETL-listed, RoHS-Compliant
- 1000 ft Pull Box or Wooden Spool

**Compatible with VC RJ45 plugs:**

011-016-100 | 011-017-100 | 011-018/EZF-100  
011-019/EZF-100 | 011-020G-100

Item #	Description
059-485/CMXF	CAT5E PoE Type 3, 350 MHz, Direct Burial, Gel-Flooded Core, <b>Unshielded</b> , 1000 ft, Box, Black
059-489/WS/CMXF	CAT5E PoE Type 3, 350 MHz, Direct Burial, Gel-Flooded Core, <b>Unshielded</b> , 1000 ft, Spool, Black
059-487/S/CMXF	CAT5E PoE Type 3, 350 MHz, Direct Burial, Gel-Flooded Core, <b>Shielded</b> , Drain Wire, LLDPE Jacket, 1000 ft, Spool, Black

## CAT5E 25 Pair Direct Burial

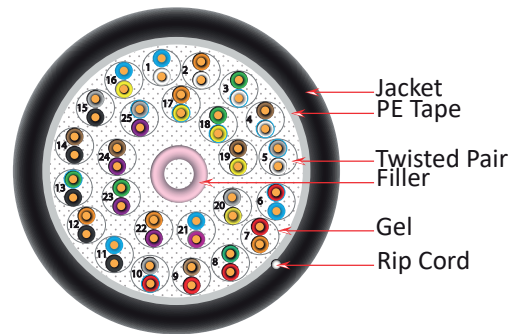
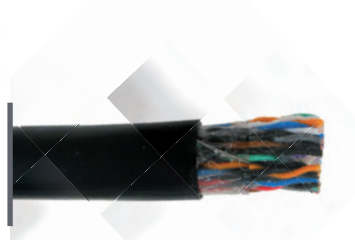

**Features:**

- Supports PoE Type 3 (IEEE 802.3bt) up to 60 W
- Gel-Flooded Core
- Outdoor and UV-Resistant Jacket Material
- 24-AWG solid bare copper conductors
- Exceeds ANSI/TIA-568.2-D and ISO/IEC 11801
- ETL-listed, RoHS-Compliant
- 1000 ft Wooden Spool

Item #	Description
059-488/CMXF25P	CAT5E PoE Type 3, 350 MHz, CMXF Direct Burial, Gel-Flooded Core, 50-Conductor, 24 AWG Solid Bare Copper, Black

# CAT3 Cable

## CAT3 Solid 25, 50, 100 Pair CMR UTP

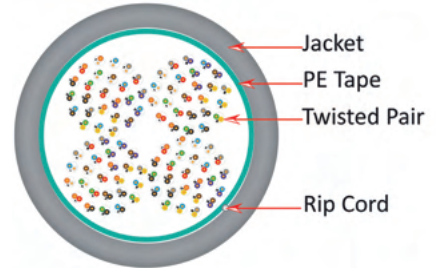
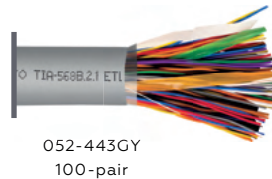
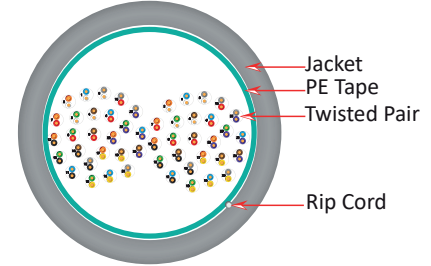
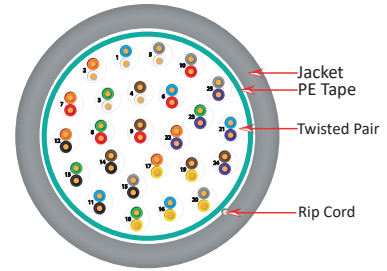

### Features:

- o 24 AWG Solid Bare Copper Conductors
- o PE Tape, Rip Cord
- o ETL-listed, RoHS-Compliant
- o Riser Fire Safety Rating (CMR)
- o Supplied in 1000 ft



Item #	Description
052-441GY	CAT3 UTP, 24 AWG, 25-Pair, Gray
052-442GY	CAT3 UTP, 24 AWG, 50-Pair, Gray
052-443GY	CAT3 UTP, 24 AWG, 100-Pair, Gray



## Silver Satin: 4 & 6 Conductor

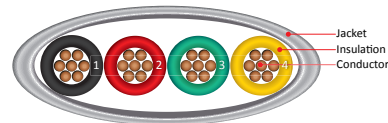

### Features:

- o Silver Satin Phone Cord
- o 7-Strand CCA Conductors
- o 4 Conductor (RJ11) & 6 Conductor (RJ12)
- o RoHS-Compliant
- o 1000 ft Spool



Item #	Description
091-719/4C/1K	Phone Cord, <b>4-Conductor</b> , 28 AWG, Silver Satin, Stranded, 1000-ft Spool
091-722/6C/1K	Phone Cord, <b>6-Conductor</b> , 28 AWG, Silver Satin, Stranded, 1000-ft Spool



## Punch Down Blocks & Accessories



078-1025



091-1P/CC/WB/B



048-120/WDS

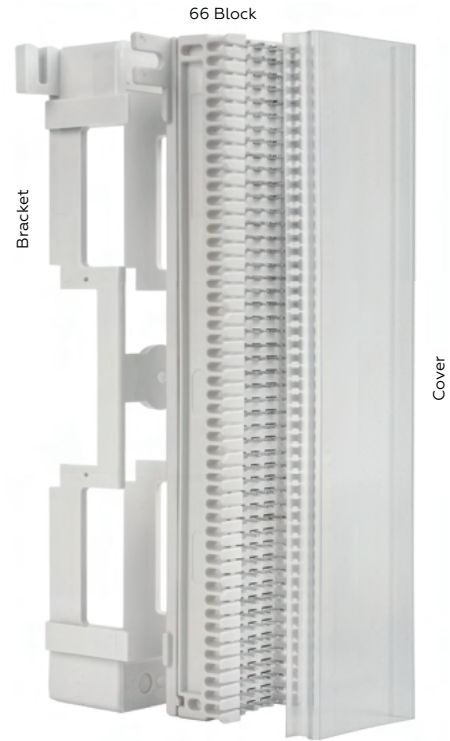

043-400/66K

**Features:**

- Industry-standard punch-down block design
- Wire spool guides and manages multipair cables
- Compatible with CAT3 and CAT5e multipair

Item #	Description
043-400/66K	66 Block, 50-Strip Punch down Block with Cover, Bracket and Labeling Strips
048-120/WDS	Wire Distribution Spool, White
091-1P/CC/WB/B	Cross Connect Cable, 1 Pair, 1000 ft
078-1025	Impact punch down tool with 110/88/66 blade



## Telephone Cords (Terminated)



4C



6C

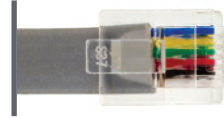
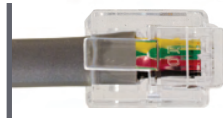

**Features:**

- Silver Satin Phone Cord
- 7-Strand CCA Conductors
- 6P4C (RJ11 Termination) and 6P6C (RJ12 Termination)
- RoHS-Compliant
- Available in 7 FT, 14 FT, 25 FT
- Straight-through pinout

Length	4 Conductor	6 Conductor
7 FT	091-701/4C/7S	091-710/6C/7S
14 FT	091-704/4C/14S	091-713/6C/14S
25 FT	091-707/4C/25S	091-716/6C/25S



# Audio Cable

HIGH-STRAND AUDIO CABLE							
UNSHIELDED							
10/2							
105 strand							
209-2335/5WH - 500 ft spool							
12/2	12/4	14/2	14/4	16/2	16/4	18/2	18/4
65 strand		41 strand		65 strand		16 strand	
209-2324/BK 500 ft pull box	209-2319/BK 500 ft spool	209-2320/BK 500 ft pull box	209-2321/BK 500 ft pull box	209-2315/BK 500 ft pull box	209-2316/BK 500 ft pull box	209-2328/BK 500 ft pull box	209-2329/BK 500 ft pull box
209-2324 500 ft pull box	209-2319 500 ft spool	209-2320 500 ft pull box	209-2321 500 ft pull box	209-2315 500 ft pull box	209-2316 500 ft pull box	209-2328 500 ft pull box	209-2329 500 ft pull box
		209-2320/PR 500 ft pull box	209-2321/PR 500 ft pull box	209-2315/PR 500 ft pull box	209-2316/PR 500 ft pull box		
		209-2322 1000 ft spool	209-2323 1000 ft spool	209-2317 1000 ft spool	209-2318 1000 ft spool	209-2327 1000 ft pull box	
				209-2317/PR 1000 ft spool	209-2318/PR 1000 ft spool		
		105 strand					
		209-2325 500 ft pull box	209-2326 500 ft pull box				
			209-2326/WS/ WH 500 ft spool				
SHIELDED							
14/2							
14/4							
16/2							
16/4							
105 strand							
65 strand							
		209-2347/S/5WH 500 ft pull box	209-2351/S/5WH 500 ft pull box	209-2355/S/5WH 500 ft pull box	209-2359/S/5WH 500 ft pull box		
DIRECT BURIAL							
12/2	12/4	14/2	14/4	16/2	16/4	18/2	18/4
65 strand		105 strand		65 strand		16 strand	
209-2324/DB 500 ft spool	209-2319/DB 500 ft spool	209-2320/DB 500 ft pull box	209-2321/DB 500 ft spool	209-2315/DB 500 ft pull box	209-2316/DB 500 ft pull box	209-2328/DB 500 ft pull box	209-2329/DB 500 ft pull box





**UNSHIELDED**

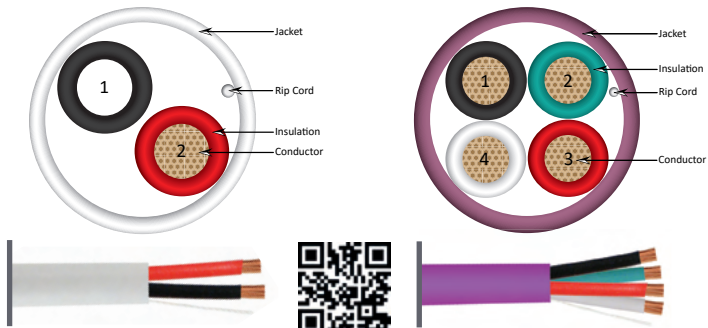

**Features:**

- Conductors: Oxygen-Free Stranded Bare Copper
- Stranded Conductors Provide Additional Flexibility
- Insulation Material: PVC
- Flame Retardant Test: CMR CL3
- ETL-listed, RoHS-Compliant
- Available in a Wooden Spool or Pull Box

**Direct Burial Features:**

- Durable Weather Resistant Jacket
- High-Strand Oxygen Free Bare Copper Conductors
- Suitable for Direct Burial Applications
- UV Rated Outer Jacket
- Water Block Tape

**SHIELDED**

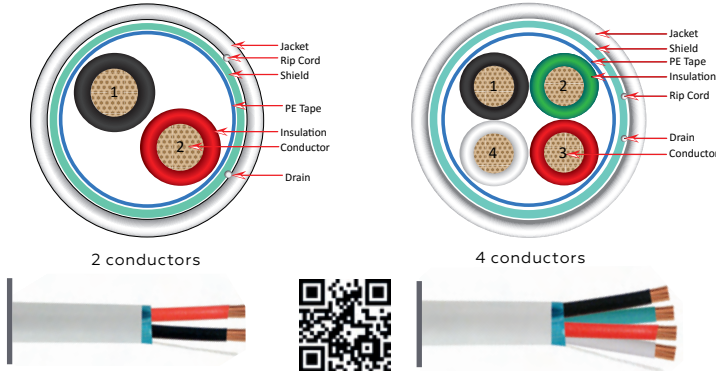

**DIRECT BURIAL**

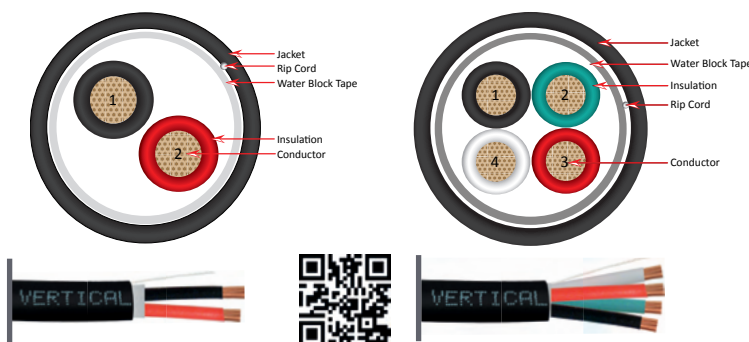

# Coaxial Cable

Coaxial Cable		
	Standard	Quad
<b>RG6</b>	<b>Bare Copper Conductor</b>	
	<b>ETL</b> 107-2312/WH (CM) 107-2311/BK (CM) 107-2311/BK/RB (CM)	<b>ETL</b> 107-2309/BK (CM) 107-2310/WH (CM)
	<b>Copper-Clad Steel (CCS) Conductors</b>	
	<b>ETL</b> 107-1956BK6SR (CMR) 107-1957WH6SR (CMR) 107-1234BK6S1BX (CM) 107-1237WH6S1BX (CM) 107-1234BK6S1RB (CM) 107-1237WH6S1RB (CM) 107-1235BK6S500 (CM) 107-1236WH6S500 (CM)	<b>ETL</b> 107-1952BK6Q1BX (CM) 107-1953WH6Q1BX (CM) 107-1954BK6Q500 (CM) 107-1955WH6Q500 (CM) 107-1952BK6Q1WS (CM)
	<b>CCS with Messenger</b>	
	<b>ETL</b> 107-1233BK/MESG (CM)	-
	<b>Copper-Clad Steel (CCS) with Plenum Jacket</b>	
	<b>ETL</b> 107-2316/P/WH (CMP) 107-2316/P/BK (CMP)	<b>ETL</b> 107-2315/P/WH (CMP) 107-2315/P/BK (CMP)
	<b>Copper-Clad Steel (CCS) Direct Burial (Gel-Flooded Core)</b>	
	<b>ETL</b> 107-1234/DB/6S	<b>ETL</b> 107-1952/DB/6Q
<b>RG59</b>	<b>95% Copper Clad Aluminum (CCA) Siamese with 18/2 Power Cables</b>	
	<b>ETL</b> 107-2179/BK (CM)	
	<b>85% Copper Clad Aluminum (CCA) Siamese with 18/2 Power Cables</b>	
<b>ETL</b> 107-2321/BK (CM) 107-2322/WH (CM) 107-2323/BK (CM) 107-2324/WH (CM)		
<b>RG11</b>	<b>Copper-Clad Steel (CCS) Conductors</b>	
	<b>ETL</b> 107-1032BK/R11 (CM)	<b>ETL</b> 107-1032BK/R11Q (CM)
	<b>Copper-Clad Steel (CCS) Direct Burial</b>	
<b>ETL</b> 107-1032DB/R11	<b>ETL</b> 107-1032DB/R11Q	

## RG6 CMP Plenum Quad Shield - CCS

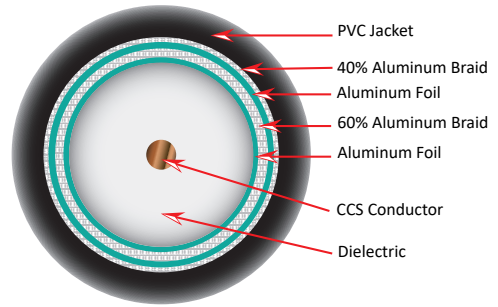

**Features:**

- High-Grade RG6 Coaxial Cable
- Suitable for Digital HDTV Applications, CATV
- 18 AWG Solid CCS Conductor
- Shield: Aluminum Foil, 60% Aluminum Braid, Aluminum Foil, 40% Aluminum Braid
- CMP-Rated
- ETL-listed, RoHS-Compliant
- 1000 ft Wooden Spool

Item #	Description
107-2315/P/BK	1000 ft Spool, Black
107-2315/P/WH	1000 ft Spool, White



3G Sweep Tested - Explained  
Engineered for high-performance video and data transmission, each cable is 3G sweep tested to ensure consistent signal quality across the required frequency range. Perfect for HDTV, CCTV, and broadband applications

## RG6 CM Quad Shield - Bare Copper

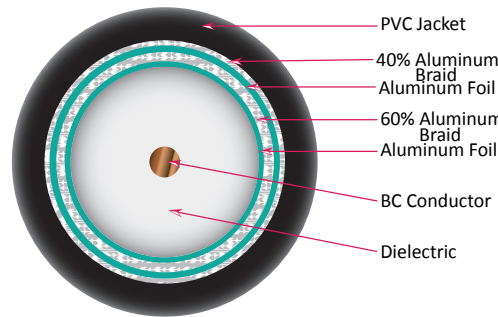
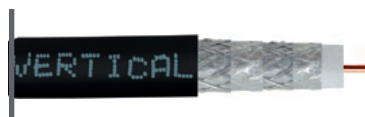

**Features:**

- High-Grade RG6 Coaxial Cable
- Suitable for Digital HDTV Applications, CATV and Digital Satellite Installations
- 18 AWG Solid Bare Copper Conductor
- Shield: Aluminum Foil, 60% Aluminum Braid, Aluminum Foil, 40% Aluminum Braid
- Fully Sweep Tested to 3.0 GHz
- CM, CATV, CL2
- ETL-listed, RoHS-Compliant

Item #	Description
107-2309/BK	Solid Bare Copper Conductor, 1000 ft, Pull Box, Black
107-2310/WH	Solid Bare Copper Conductor, 1000 ft, Pull Box, White

Coaxial Cable » RG6

**RG6 CM Quad Shield - CCS**

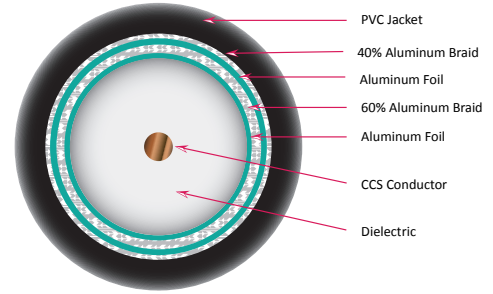

**Features:**

- High-Grade RG6 Quad Shield
- Suitable for Digital HDTV applications, CATV, TV antenna and Satellite TV
- 18 AWG Copper Clad Steel Conductor
- Shield: Aluminum Foil, 60% Aluminum Braid, Aluminum Foil, 40% Aluminum Braid
- Sweep Tested to 3.0 GHz
- CM, CL2 Rated
- ETL-listed, RoHS-Compliant



Item #	Description
107-1954BK6Q500	500 ft Pull Box, Black
107-1955WH6Q500	500 ft Pull Box, White
107-1952BK6Q1BX	1000 ft Pull Box, Black
107-1953WH6Q1BX	1000 ft Pull Box, White

**Related products:**



[078-1018](#) [P80](#)



[037-319WH/3G](#) [P77](#)



[083-1042/CP/Q](#) [P77](#)

**RG6 CMP Plenum Standard Shield - CCS**

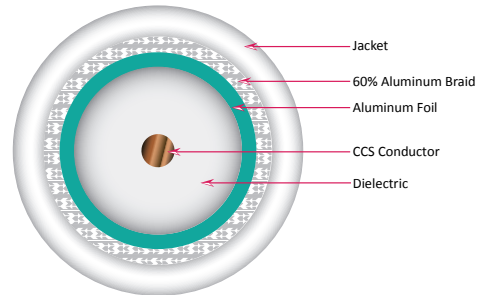

**Features:**

- High-Grade RG6 Coaxial Cable
- Suitable for Digital HDTV Applications, CATV
- 18 AWG Solid CCS Conductor
- Shield: Aluminum Foil, 60% Aluminum Braid
- CMP-Rated (Plenum)
- ETL-listed, RoHS-Compliant
- 1000 ft Wooden Spool



Item #	Description
107-2316/P/BK	1000 ft Spool, Black
107-2316/P/WH	1000 ft Spool, White

## RG6 CM Standard Shield - Bare Copper

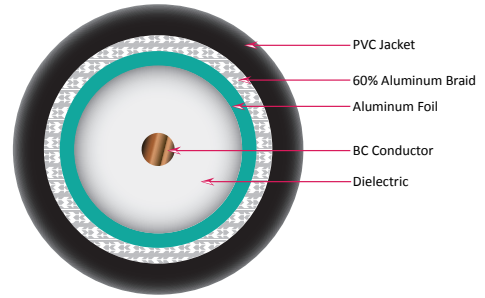

**Features:**

- High-Grade RG6 Coaxial Cable Suitable for Digital HDTV Applications, CATV and Digital Satellite Installations
- 18 AWG Solid Bare Copper Conductor
- Shield: Aluminum Foil, 60% Aluminum Braid
- Fully Sweep Tested to 3.0 GHz
- CM, CATV, CL2
- ETL-listed, RoHS-Compliant

Item #	Description
107-2311/BK	Solid Bare Copper Conductor, 1000 ft, Pull Box, Black
107-2311/BK/RB	Solid Bare Copper Conductor, 1000 ft, Reel-in-Box, Black
107-2312/WH	Solid Bare Copper Conductor, 1000 ft, Pull Box, White



## RG6 CM & CMR Standard Shield - CCS

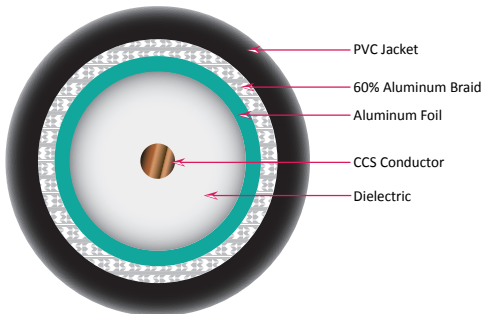

**Features:**

- High-Grade RG6 Coaxial Cable Suitable for Digital HDTV Applications, CATV and Digital Satellite Installations
- 18 AWG Solid Copper-Clad Steel Conductor
- Shield: Aluminum Foil, 60% Aluminum Braid
- Fully Sweep Tested to 3.0 GHz
- CM & CMR, CATV, CL2
- ETL-listed, RoHS-Compliant

Item #	Description
107-1235BK6S500	CCS Conductor, 500 ft Pull Box, Black - <b>CM</b>
107-1236WH6S500	CCS Conductor, 500 ft Pull Box, White - <b>CM</b>
107-1234BK6S1BX	CCS Conductor, 1000 ft Pull Box, Black - <b>CM</b>
107-1237WH6S1BX	CCS Conductor, 1000 ft Pull Box, White - <b>CM</b>
107-1234BK6S1RB	CCS Conductor, 1000 ft, Reel-in-Box, Black - <b>CM</b>
107-1237WH6S1RB	CCS Conductor, 1000 ft, Reel-in-Box, White - <b>CM</b>
107-1956BK6SR	CCS Conductor, 1000 ft Pull Box, Black - <b>CMR</b>
107-1957WH6SR	CCS Conductor, 1000 ft Pull Box, White - <b>CMR</b> ,

Coaxial Cable » RG6

**RG6 Quad & Standard Shield Direct Burial - CCS**

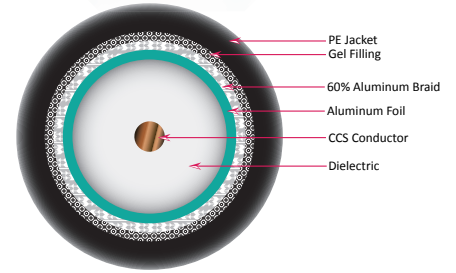
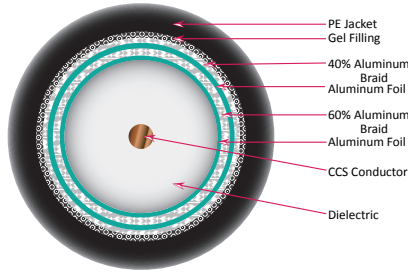
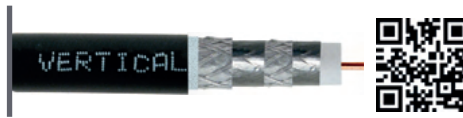

**Features:**

- High-Grade RG6 Quad Shield Direct Burial Cable
- 18 AWG Copper-Clad Steel (CCS) Conductor
- Quad Shield: Aluminum Foil + 60% Braid + Aluminum Foil + 40% Braid
- 75 Ohm Impedance
- Durable Polyethylene (PE) Jacket
- Gel-Filled Core for Direct Burial Applications
- ETL-Verified, RoHS-Compliant
- 1000 ft Spool



Item #	Description
107-1952/DB/6Q	RG6, Direct Burial, CCS Conductor, Quad Shield: Aluminum Foil, 60% Aluminum Braid, Aluminum Foil, 40% Aluminum Braid, Gel-Coated, 18 AWG, 3.0 GHz, 1000 ft Spool, Black
107-1234/DB/6S	RG6, Direct Burial, CCS Conductor, Dual Shield: Aluminum Foil, 60% Aluminum Braid, Gel Filling, 18 AWG, 3.0 GHz, 1000 ft Spool, Black

**RG6 Standard Shield With Messenger - CCS**

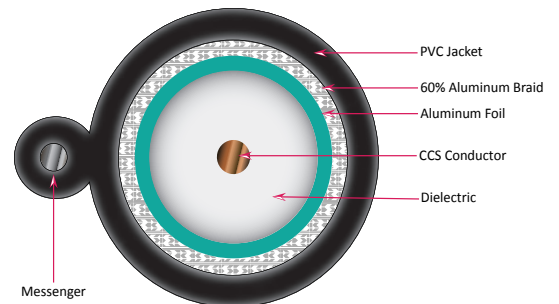

**Features:**

- High-Grade RG6 Coaxial Cable with Messenger for Aerial Installations
- 18 AWG Copper-Clad Steel (CCS) Center Conductor
- Dual Shield: Aluminum Foil + 60% Aluminum Braid
- 75 Ohm Impedance
- PVC Jacket, CM Rated, UV-Resistant
- CATV / CL2 Rated
- ETL-Listed, RoHS-Compliant

Item #	Description
107-1233BK/MESG	RG6, with messenger, CCS Conductor, Dual Shield: Aluminum Foil, 60% Aluminum Braid, 18 AWG, 1000 ft Spool, Black



048-301/TC

P116

## RG59 Siamese Cable 95% CCA Braid

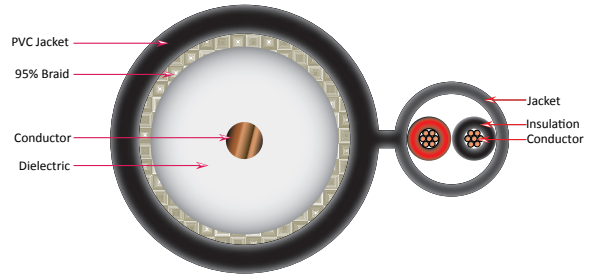

**Features:**

- o Siamese RG59 Coaxial Cable with Integrated Power
- o 20 AWG Solid Bare Copper Center Conductor
- o 95% CCA Braid for Enhanced Signal Protection
- o 18 AWG Stranded Power Conductors
- o CM Rated Jacket for Indoor Installations
- o Optimized for CCTV and Security Applications
- o ETL-Listed, RoHS-Compliant
- o Available in 1000 ft

Item #	Description
107-2179/BK	RG59 Siamese, + 18 AWG Power Cables, Shield: 95% CCA Braid, 20 AWG, 1000 ft Spool, Black

## RG59 Siamese Cable 85% CCA Braid with 18/2 Power Cable

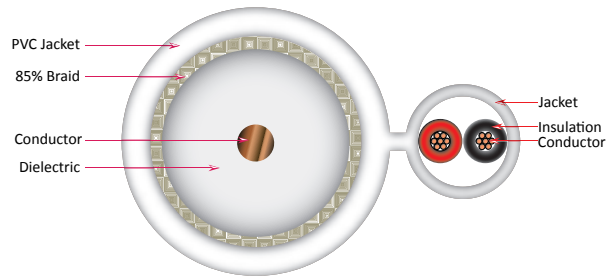

**Features:**

- o Siamese RG59 Coaxial Cable with 18 AWG Stranded Power Conductors
- o Optimized for CCTV Video and Power Transmission
- o 20 AWG Copper-Clad Steel (CCS) Center Conductor
- o 85% CCA Braid Coverage for Signal Protection
- o CM Rated Jacket, CL2 Rated Cable
- o ETL-Verified, RoHS-Compliant
- o Available in 1000 ft Wooden Spool and 500 ft Reel-in-Box

Item #	Description
107-2321/BK	1000 ft, Spool, Black
107-2322/WH	1000 ft, Spool, White
107-2323/BK	500 ft, Reel-in-Box, Black
107-2324/WH	500 ft, Reel-in-Box, White

Coaxial Cable » RG11

**RG11 Quad Shield & Standard Shield - CCS Conductor**

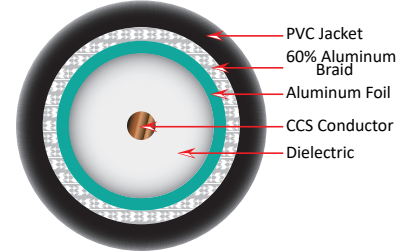
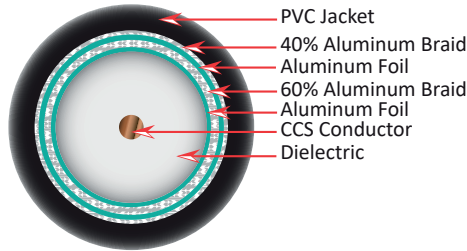

**Features:**

- High-Grade RG11 Quad Shield
- 14 AWG CCS Solid Conductor
- Shield: Aluminum Foil, 60% Aluminum Braid, Aluminum Foil, 40% Aluminum Braid
- 75 Ohm Impedance
- ETL-listed, RoHS-Compliant
- Supplied in 1000 ft Spool

Item #	Description
107-1032BK/R11Q	RG11, CCS Conductor, Quad Shield: Aluminum Foil, 60% Aluminum Braid, Aluminum Foil, 40% Aluminum Braid, 14 AWG, CL2, CM, PVC Jacket, 1000 ft Spool, Black
107-1032BK/R11	RG11, CCS Conductor, Shield: Aluminum Foil, 60% Aluminum Braid, 14 AWG, CL2 Rated, 1000 ft Spool, Black

**RG11 Quad Shield & Standard Shield - CCS Direct Burial**

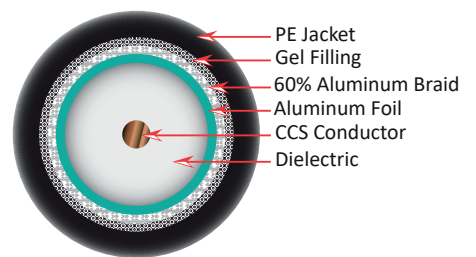
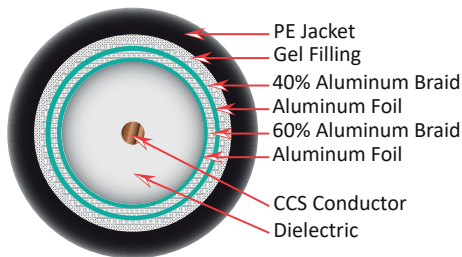

**Features:**

- High-Grade RG11 Direct Burial
- 14 AWG CCS Solid Conductor
- Shield: Aluminum Foil, 60% Aluminum Braid, Aluminum Foil, 40% Aluminum Braid
- Direct Burial Gel Filled
- 75 Ohm Impedance
- ETL-Verified, RoHS-Compliant

Item #	Description
107-1032/DB/R11Q	RG11 Direct Burial, CCS Conductor, Quad Shield: Aluminum Foil, 60% Braid, Aluminum Foil, 40% Aluminum Braid, Gel Filled, 14 AWG, PE Jacket, 1000 ft Spool, Black
107-1032/DB/R11	RG11 Direct Burial, CCS Conductor, Dual Shield: Aluminum Foil, 60% Braid, Gel Filled, 14 AWG, CL2, PE Jacket, 1000 ft Spool, Black

# WHY VERTICAL CABLE?



## FOUR U.S. DISTRIBUTION CENTERS

Strategically located to deliver where and when you need it.



## MANUFACTURING PLANT

Proudly manufacturing quality products in the United States.



## SAME-DAY SHIPPING

Orders ship the same day—because your time matters.



## FIVE-STAR CUSTOMER SUPPORT

Real people. Real answers. Real solutions.



## PROVEN, HIGH-PERFORMANCE PRODUCTS

Engineered for reliability. Built to perform.

### STANDARDS YOU CAN TRUST

MADE IN THE USA  
(SELECT PRODUCTS)



TAA  
COMPLIANT



ROHS  
COMPLIANT



ETL  
LISTED



### INDUSTRY PARTNERSHIPS



TEKNOLEDGE  
WORLDWIDE



# Access Control Cable

## 22/3 Pair (Shielded) + 18/4 + 22/4 + 22/2

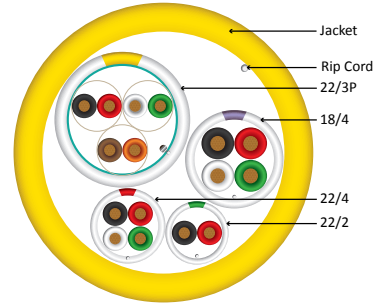

### Features:

- o 4 Component Lighting Control Cable
- o Each component contains a rip cord
- o ETL-listed, RoHS Compliant
- o 500 ft Spool and 1000 ft Wooden Spool

### Components:

- 22 AWG / 3 Pair Shielded
- 18 AWG / 4 Conductor,
- 22 AWG / 4 Conductor,
- 22 AWG / 2 Conductor

### Applications:

Access Control Panels, Security Panels, Card Readers, Sensors, Keypads, Power, Microphones, Speakers, Alarm Systems

Item #	Description
214-2325/GR	22/3P Shielded + 18/4 + 22/4 + 22/2 Lighting Control Cable <b>Riser-Rated</b> , 500 ft, Green, Spool
214-2329/P/WH	22/3P Shielded + 18/4 + 22/4 + 22/2 Lighting Control Cable <b>Plenum-Rated</b> , 500 ft, White, Spool
214-2330/P/YL	22/3P Shielded + 18/4 + 22/4 + 22/2 Lighting Control Cable <b>Plenum-Rated</b> , 500 ft, Yellow, Spool
214-2333/P/YL1K	22/3P Shielded + 18/4 + 22/4 + 22/2 Lighting Control Cable <b>Plenum-Rated</b> , 1000 ft, Yellow, Spool
214-2334/P/BK1K	22/3P Shielded + 18/4 + 22/4 + 22/2 Lighting Control Cable <b>Plenum-Rated</b> , 1000 ft, Black, Spool
214-2342/P/WH1K	22/3P Shielded + 18/4 + 22/4 + 22/2 Lighting Control Cable <b>Plenum-Rated</b> , 1000 ft, White, Spool
214-2331/PBX/YL	22/3P Shielded + 18/4 + 22/4 + 22/2 Lighting Control Cable <b>Plenum-Rated</b> , 500 ft, Yellow, Reel in box

# OSDP Cable CMP Plenum-Rated

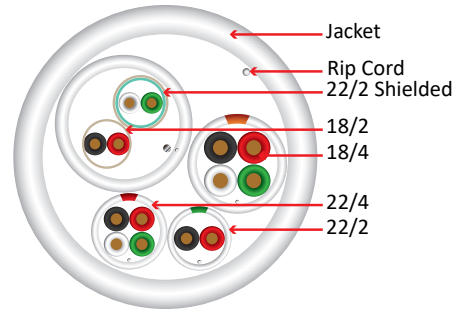

### Features:

- o CMP plenum-rated OSDP cable
- o EMI/RFI Protection (Shielded Pair Only)
- o Easy-strip rip cord
- o ETL-listed, RoHS Compliant
- o 1000 ft Wooden Spool

Item #	Description
214-2363/P/WH1K	22 AWG 1 Pair Shielded + 18/2, 18/4, 22/4, 22/2 OSDP Cable, Plenum-Rated, 1000 ft, <b>White</b> , Spool
214-2364/P/YL1K	22 AWG 1 Pair Shielded + 18/2, 18/4, 22/4, 22/2 OSDP Cable, Plenum-Rated, 1000 ft, <b>Yellow</b> , Spool

## Control Cable: 22/2 (Shielded) + 18/2

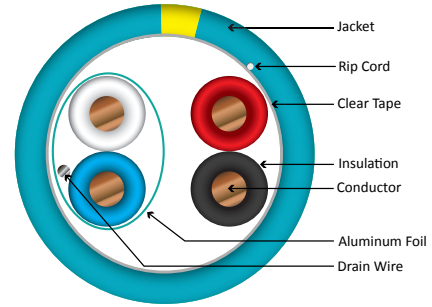

### Features:

- Control Cable
- Riser-Rated CL3R & Plenum-Rated CL3P
- ETL-listed, RoHS-Compliant
- 1000 ft Spool

### Applications:

Touch Panels, Key Pads, Expansion Modules, Tuners, Power Limited Control Circuits, Access Control Panels, Security Panels, Card Readers, Sensors, Keypads, Power, Microphones, Speakers, Alarm Systems

Item #	Description
214-2321/TL	22/2 Shielded + 18/2 Stranded Bare Copper Conductors, <b>CL3R Riser-Rated</b> , 1000 ft, Wooden Spool, Teal with Yellow Stripe
214-2320/P/TL	22/2 Shielded + 18/2 Stranded Bare Copper Conductors, <b>CL3P Plenum-Rated</b> , 1000 ft, Wooden Spool, Teal with Yellow Stripe

## Control Cable: 22/2 (Shielded) + 16/2

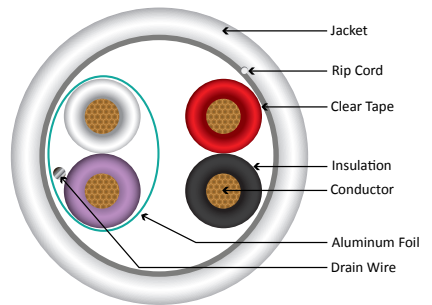

### Features:

- High Grade Lighting Control System Cable
- In-home, commercial, and industrial lighting applications
- Used in conjunction with security & sensor systems
- Indoor Applications
- Riser-Rated CL3R & Plenum-Rated CL3P
- ETL-listed, RoHS-Compliant
- 1000 ft Spool

### Applications:

High Grade Lighting Control System Cable In-home, commercial, and industrial lighting applications. Used in conjunction with security & sensor systems Indoor Applications, Light Dimmers, environmental sensors, smart eco-friendly lighting control

Item #	Description
214-2323/WH	22/2 Shielded + 16/2 Stranded Bare Copper Conductors, <b>CL3R Riser-Rated</b> 1000 ft, Wooden Spool, White
214-2332/P/WH	22/2 Shielded + 16/2 Stranded Bare Copper Conductors, <b>CL3P Plenum-Rated</b> 1000 ft, Wooden Spool, White

# Security Cable

## SECURITY CABLE - PLENUM-RATED

UNSHIELDED - STRANDED CONDUCTORS						
12/2	12/4	14/2	14/4	16/2	16/4	18/2
19 strand		19 strand		19 strand		7 strand
211-122/P/5WH 500 ft spool	211-124/P/5WH 500 ft spool	211-142/P/WH 1000 ft pull box 211-142/P/5WH 500 ft pull box	211-144/P/WH 1000 ft spool 211-144/P/5WH 500 ft pull box	211-162/P/WH 1000 ft pull box 211-162/P/5WH 211-162/P/5BK 500 ft pull box	211-164/P/WH 1000 ft pull box 211-164/P/5WH 211-164/P/5BK 500 ft pull box	211-182/P/WH 1000 ft pull box 211-182/P/5WH 500 ft pull box
SHIELDED - STRANDED						
				16/2	16/4	18/2
				19 strand		7 strand
				211-162/S/P/WH 1000 ft pull box 211-162/S/P/5WH 500 ft pull box	211-164/S/P/WH 1000 ft spool 211-164/S/P/5WH 500 ft pull box	211-182/S/P/WH 1000 ft pull box 211-182/S/P/5WH 500 ft pull box

## SECURITY CABLE - NON-PLENUM

UNSHIELDED - STRANDED CONDUCTORS			
18/2	18/4	18/6	18/8
19 strand			7 strand
211-182ST/WH 1000 ft pull box  211-182ST/5WH 211-182ST/5GY 500 ft pull box	211-184ST/WH 1000 ft pull box  211-184ST/5WH 211-184ST/5GY 500 ft pull box	211-186ST/GY 1000 ft spool  211-186ST/5GY 500 ft spool	211-188ST/GY 1000 ft spool
SHIELDED - STRANDED			
18/2	18/4	18/6	18/8
19 strand			7 strand
211-182ST/S/WH 1000 ft pull box  211-182ST/S/5WH 500 ft pull box	211-184ST/S/WH 1000 ft spool  211-184ST/S/5GY 500 ft pull box	211-186ST/S/GY 1000 ft spool  211-186ST/S/5GY 500 ft spool	211-188ST/S/GY 1000 ft spool

## SECURITY CABLE - DIRECT BURIAL

SHIELDED - STRANDED CONDUCTORS					
18/2	18/4	18/6	18/8	22/4	22/6
16 strand				7 strand	
211-182ST/S/DB 1000 ft spool	211-184ST/S/DB 1000 ft spool	211-186ST/S/DB 1000 ft spool	211-188ST/S/5DB 500 ft spool	210-224ST/S/5DB 500 ft box	210-226ST/S/5DB 500 ft box
UNSHIELDED - STRANDED					

22/4
210-224ST/DB 500 ft box



## SECURITY CABLE - PLENUM-RATED

### UNSHIELDED - STRANDED CONDUCTORS

18/4	18/6	22/2	22/4	22/6	22/8
19 strand	7 strand	7 strand			
211-184/P/WH 1000 ft pull box 211-184/P/5WH 500 ft pull box	211-186ST/P/WH 1000 ft spool	210-222/P/WH 1000 ft pull box	210-224/P/WH 1000 ft pull box	210-226/P/WH 1000 ft spool	210-228/P/WH 1000 ft spool

### SHIELDED - STRANDED

18/4	18/6	22/4	22/6
19 strand	7 strand	7 strand	
211-184/S/P/5WH 500 ft pull box	211-186/S/P/5WH 500 ft spool	210-224/S/P/WH 1000 ft spool	210-226/S/P/WH 1000 ft spool

## SECURITY CABLE - NON-PLENUM

### UNSHIELDED - STRANDED CONDUCTORS

### UNSHIELDED - SOLID CONDUCTORS

22/2	22/4	22/6	22/8	22/2	22/4
7 strand				SOLID CONDUCTOR	
210-222ST/GY 210-222ST/WH 1000 ft pull box 210-222ST/5GY 210-222ST/5WH 500 ft pull box 212-222ST/5WH 212-222ST/5BL 500 ft coil pack	210-224ST/GY 210-224ST/WH 1000 ft pull box 210-224ST/5GY 210-224ST/5WH 500 ft pull box 212-224ST/5WH 500 ft coil pack	210-226ST/GY 210-226ST/WH 1000 ft pull box  210-226ST/5GY 210-226ST/5WH 500 ft pull box	210-228ST/GY 1000 ft pull box  210-228ST/5GY 500 ft pull box	210-222SO/GY 210-222SO/WH 1000 ft pull box  212-222SO/5GY 212-222SO/5WH 500 ft coil pack	210-224SO/WH 1000 ft pull box  212-224SO/5WH 212-224SO/5GY 500 ft coil pack

### SHIELDED - STRANDED

### SHIELDED - SOLID

22/2	22/4	22/6	22/8	22/2	22/4
7 strand				SOLID CONDUCTOR	
210-222ST/S/GY 1000 ft pull box  210-222ST/S/5GY 210-222ST/S/5WH 500 ft pull box	210-224S/WH 1000 ft pull box  210-224ST/S/5GY 210-224ST/S/5WH 500 ft pull box	210-226ST/S/WH 210-226ST/S/GY 1000 ft pull box 210-226ST/S/5GY 210-226ST/S/5WH 500 ft pull box	210-228ST/S/GY 1000 ft pull box  210-228ST/S/5GY 500 ft pull box	210-222SO/S/5WH 500 ft pull box	210-224SO/S/WH 1000 ft pull box  210-224SO/S/5GY 500 ft pull box



## Security Cable

## STRANDED CONDUCTORS

## UNSHIELDED

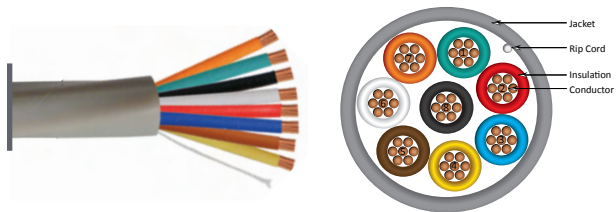
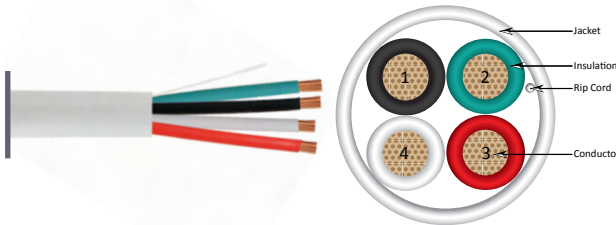
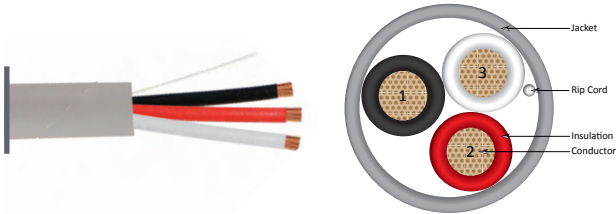
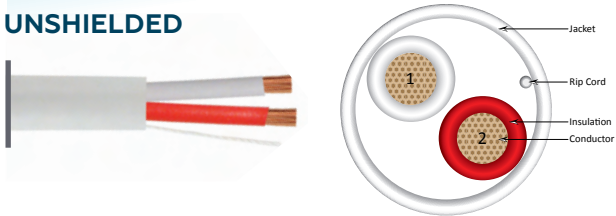

## SHIELDED

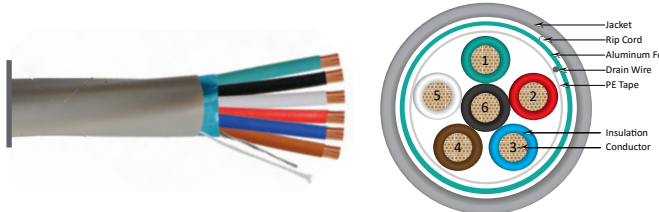
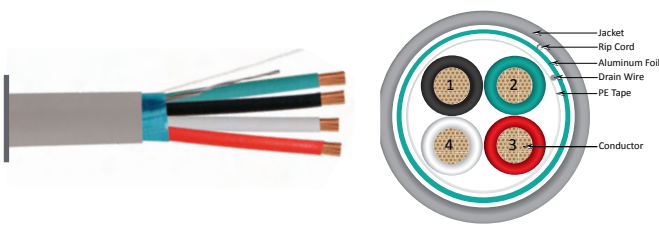
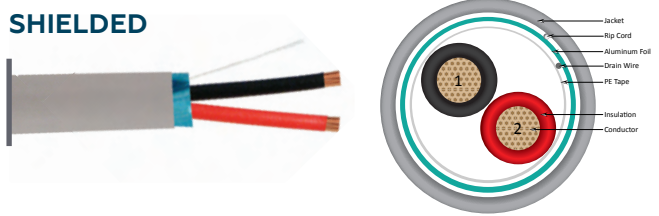

## Features:

- Conductor: Stranded Bare Copper and Solid Bare Copper
- Non-Plenum: CM CL2
- Plenum-Rated: CMP CL3P
- Sequential Length Markings on Jacket
- 500 ft or 1000 ft (Pull Box, Spool or Coil Pack)
- ETL-listed, RoHS-Compliant

## Applications:

- Indoor Remote Control of Security
- Intercom Systems
- Sound / Audio Systems
- Door Controllers, Prox Sensors, Key Pads, Access Control, Smoke Detectors
- Indoor Applications



# Security Cable

## SOLID CONDUCTORS

### UNSHIELDED

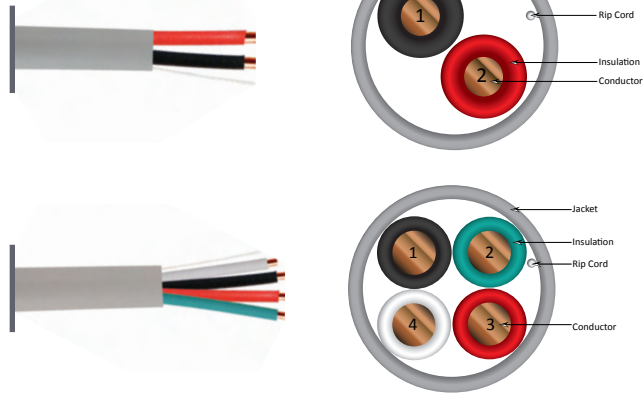

### SHIELDED

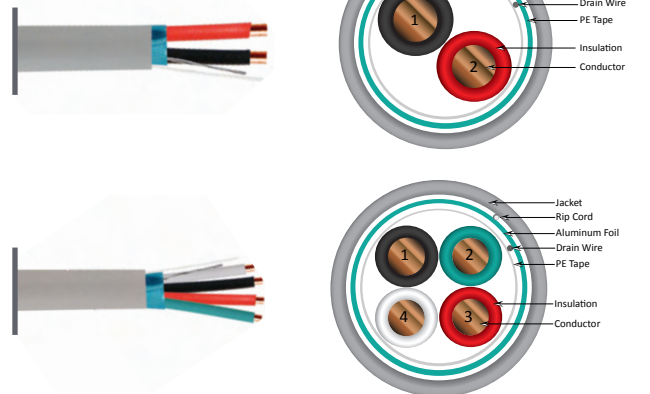

## DIRECT BURIAL

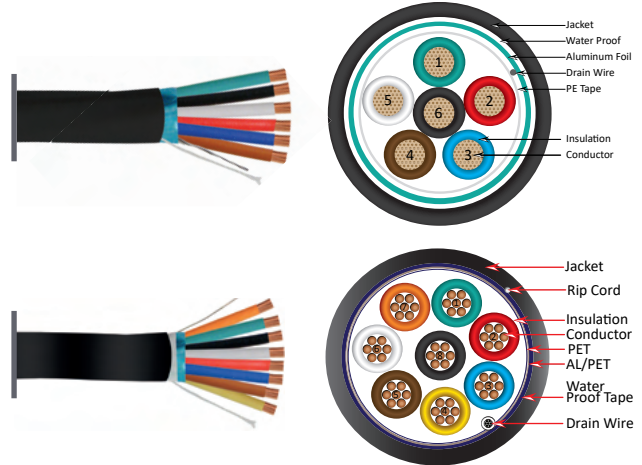
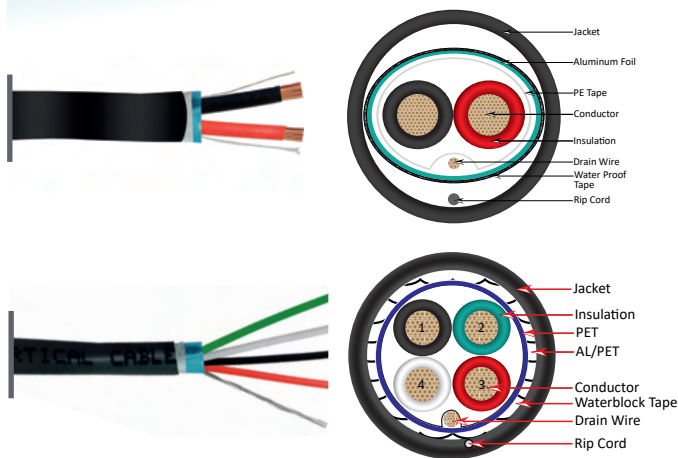

## Packaging Options Available



# Fire Alarm Cable

## FPLP, Plenum-Rated

### UNSHIELDED

Item # Description

216-122/P/RD 12/2 Alarm Cable, FPLP, Unshielded, Solid Bare Copper Conductors, 1000 ft, Spool, Red

216-142/P/BK 14/2 Alarm Cable, FPLP, Unshielded, Solid Bare Copper Conductors, 1000 ft, Spool, Blue  
 216-142/P/BL 14/2 Alarm Cable, FPLP, Unshielded, Solid Bare Copper Conductors, 1000 ft, Spool, Blue  
 216-142/P/GR 14/2 Alarm Cable, FPLP, Unshielded, Solid Bare Copper Conductors, 1000 ft, Spool, Green  
 216-142/P/OR 14/2 Alarm Cable, FPLP, Unshielded, Solid Bare Copper Conductors, 1000 ft, Spool, Orange  
 216-142/P/RD 14/2 Alarm Cable, FPLP, Unshielded, Solid Bare Copper Conductors, 1000 ft, Spool, Red  
 216-142/P/WH 14/2 Alarm Cable, FPLP, Unshielded, Solid Bare Copper Conductors, 1000 ft, Spool, White  
 216-142/P/YL 14/2 Alarm Cable, FPLP, Unshielded, Solid Bare Copper Conductors, 1000 ft, Spool, Yellow

216-144/P/RD 14/4 Alarm Cable, FPLP, Unshielded, Solid Bare Copper Conductors, 1000 ft, Spool, Red

216-162/P/BK 16/2 Alarm Cable, FPLP, Unshielded, Solid Bare Copper Conductors, 1000 ft, Spool, Black  
 216-162/P/BL 16/2 Alarm Cable, FPLP, Unshielded, Solid Bare Copper Conductors, 1000 ft, Spool, Blue  
 216-162/P/OR 16/2 Alarm Cable, FPLP, Unshielded, Solid Bare Copper Conductors, 1000 ft, Spool, Orange  
 216-162/P/RD 16/2 Alarm Cable, FPLP, Unshielded, Solid Bare Copper Conductors, 1000 ft, Spool, Red  
 216-162/P/WH 16/2 Alarm Cable, FPLP, Unshielded, Solid Bare Copper Conductors, 1000 ft, Spool, White  
 216-162/P/YL 16/2 Alarm Cable, FPLP, Unshielded, Solid Bare Copper Conductors, 1000 ft, Spool, Yellow

216-164/P/RD 16/4 Alarm Cable, FPLP, Unshielded, Solid Bare Copper Conductors, 1000 ft, Spool, Red

216-182/P/BL 18/2 Alarm Cable, FPLP, Unshielded, Solid Bare Copper Conductors, 1000 ft, Spool, Blue  
 216-182/P/GR 18/2 Alarm Cable, FPLP, Unshielded, Solid Bare Copper Conductors, 1000 ft, Spool, Green  
 216-182/P/RD 18/2 Alarm Cable, FPLP, Unshielded, Solid Bare Copper Conductors, 1000 ft, Spool, Red  
 216-182/P/WH 18/2 Alarm Cable, FPLP, Unshielded, Solid Bare Copper Conductors, 1000 ft, Spool, White  
 216-182/P/YL 18/2 Alarm Cable, FPLP, Unshielded, Solid Bare Copper Conductors, 1000 ft, Spool, Yellow

216-184/P/BL 18/4 Alarm Cable, FPLP, Unshielded, Solid Bare Copper Conductors, 1000 ft, Spool, Blue  
 216-184/P/RD 18/4 Alarm Cable, FPLP, Unshielded, Solid Bare Copper Conductors, 1000 ft, Spool, Red  
 216-184/P/YL 18/4 Alarm Cable, FPLP, Unshielded, Solid Bare Copper Conductors, 1000 ft, Spool, Yellow

### SHIELDED

Item # Description

216-122/S/P/RD 12/2 Alarm Cable, FPLP, Shielded, Solid Bare Copper Conductors, 1000 ft, Spool, Red

216-142/S/P/BL 14/2 Alarm Cable, FPLP, Shielded, Solid Bare Copper Conductors, 1000 ft, Spool, Blue  
 216-142/S/P/GR 14/2 Alarm Cable, FPLP, Shielded, Solid Bare Copper Conductors, 1000 ft, Spool, Green  
 216-142/S/P/OR 14/2 Alarm Cable, FPLP, Shielded, Solid Bare Copper Conductors, 1000 ft, Spool, Orange  
 216-142/S/P/RD 14/2 Alarm Cable, FPLP, Shielded, Solid Bare Copper Conductors, 1000 ft, Spool, Red  
 216-142/S/P/WH 14/2 Alarm Cable, FPLP, Shielded, Solid Bare Copper Conductors, 1000 ft, Spool, White  
 216-142/S/P/YL 14/2 Alarm Cable, FPLP, Shielded, Solid Bare Copper Conductors, 1000 ft, Spool, Yellow

216-162/S/P/BL 16/2 Alarm Cable, FPLP, Shielded, Solid Bare Copper Conductors, 1000 ft, Spool, Blue  
 216-162/S/P/GR 16/2 Alarm Cable, FPLP, Shielded, Solid Bare Copper Conductors, 1000 ft, Spool, Green  
 216-162/S/P/RD 16/2 Alarm Cable, FPLP, Shielded, Solid Bare Copper Conductors, 1000 ft, Spool, Red  
 216-162/S/P/WH 16/2 Alarm Cable, FPLP, Shielded, Solid Bare Copper Conductors, 1000 ft, Spool, White  
 216-162/S/P/YL 16/2 Alarm Cable, FPLP, Shielded, Solid Bare Copper Conductors, 1000 ft, Spool, Yellow

216-164/S/P/RD 16/4 Alarm Cable, FPLP, Shielded, Solid Bare Copper Conductors, 1000 ft, Spool, Red

216-182/S/P/BL 18/2 Alarm Cable, FPLP, Shielded, Solid Bare Copper Conductors, 1000 ft, Spool, Blue  
 216-182/S/P/RD 18/2 Alarm Cable, FPLP, Shielded, Solid Bare Copper Conductors, 1000 ft, Spool, Red  
 216-182/S/P/YL 18/2 Alarm Cable, FPLP, Shielded, Solid Bare Copper Conductors, 1000 ft, Spool, Yellow

216-184/S/P/BL 18/4 Alarm Cable, FPLP, Shielded, Solid Bare Copper Conductors, 1000 ft, Spool, Blue  
 216-184/S/P/RD 18/4 Alarm Cable, FPLP, Shielded, Solid Bare Copper Conductors, 1000 ft, Spool, Red  
 216-184/S/P/YL 18/4 Alarm Cable, FPLP, Shielded, Solid Bare Copper Conductors, 1000 ft, Spool, Yellow



2 Conductor Unshielded

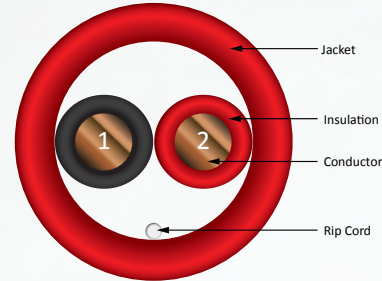

2 Conductor Shielded

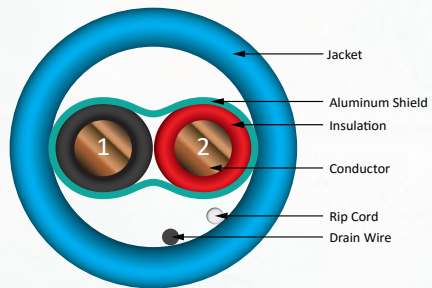

# Fire Safety in Full Spectrum.

OPTICAL FIBER

CABLE MANAGEMENT & RACKS

INDUSTRIAL & HARSH ENVIRONMENTS

## Fire Alarm Cable

### FPLR, Riser-Rated

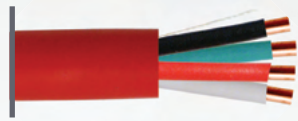

**4 Conductor  
Unshielded**

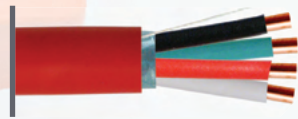
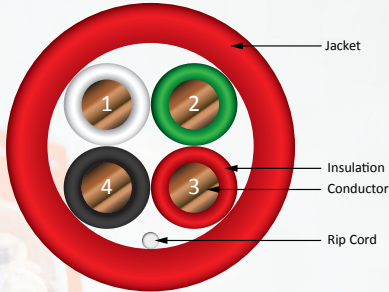

**4 Conductor  
Shielded**

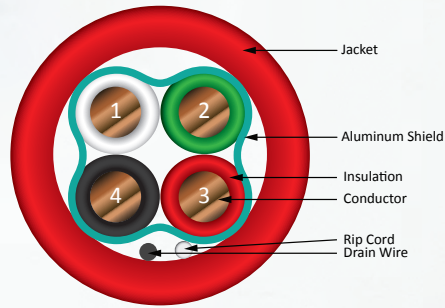

- **Seven colors**
- **FPLR & FPLP**
- **Shielded & Unshielded**
- **2, 14, 16, 18 AWG / 2, 4 Conductors**

**Features:**

- Fire protective signal circuit
- Solid Bare Copper Conductors
- ETL-listed, RoHS-Compliant

**Applications:** Smoke alarms and detectors, pull boxes, burglar alarms, addressable fire alarm systems

**UNSHIELDED**

Item #	Description
216-142/R/BL	14/2 Alarm Cable, FPLR, Unshielded, Solid Bare Copper Conductors, 1000 ft, Spool
216-142/R/RD	Colors: Blue, Red, Yellow
216-142/R/YL	
216-144/R/RD	14/4 Alarm Cable, FPLR, Unshielded, Solid Bare Copper Conductors, 1000 ft, Spool, Red
216-162/R/BL	16/2 Alarm Cable, FPLR, Unshielded, Solid Bare Copper Conductors, 1000 ft, Spool
216-162/R/RD	Colors: Blue, Red, Yellow
216-162/R/YL	
216-164/R/RD	16/4 Alarm Cable, FPLR, Unshielded, Solid Bare Copper Conductors, 1000 ft, Spool, Red
216-182/R/BL	18/2 Alarm Cable, FPLR, Unshielded, Solid Bare Copper Conductors, 1000 ft, Spool & Reel-in-Box
216-182/R/GR	Colors: Blue, Green, Red, Yellow
216-182/R/RD	
216-182/R/RB/RD	
216-182/R/YL	
216-184/R/BL	18/4 Alarm Cable, FPLR, Unshielded, Solid Bare Copper Conductors, 1000 ft, Spool
216-184/R/RD	Colors: Blue, Red, Yellow
216-184/R/YL	

**SHIELDED**

Item #	Description
216-142/S/R/BL	14/2 Alarm Cable, FPLR, Shielded, Solid Bare Copper Conductors, 1000 ft, Spool
216-142/S/R/GR	Colors: Blue, Green, Red, Yellow
216-142/S/R/RD	
216-142/S/R/YL	
216-162/S/R/BL	16/2 Alarm Cable, FPLR, Shielded, Solid Bare Copper Conductors, 1000 ft, Spool
216-162/S/R/RD	Colors: Blue, Red, Yellow
216-162/S/R/YL	
216-164/S/R/RD	16/4 Alarm Cable, FPLR, Shielded, Solid Bare Copper Conductors, 1000 ft, Spool, Red
216-182/S/R/BL	18/2 Alarm Cable, FPLR, Shielded, Solid Bare Copper Conductors, 1000 ft, Spool
216-182/S/R/RD	Colors: Blue, Red, Yellow
216-182/S/R/YL	
216-184/S/R/BL	18/4 Alarm Cable, FPLR, Shielded, Solid Bare Copper Conductors, 1000 ft, Spool
216-184/S/R/RD	Colors: Blue, Red, Yellow
216-184/S/R/YL	

Item #	Description
315-224/R/5RDCP	22/4 Alarm Cable, FPLR, Unshielded, Solid Bare Copper Conductors, 500 ft, Coil Pack, Red

# Thermostat Wire

## Thermostat Wire - CL2R & CL2P

COPPER BULK CABLE

OPTICAL FIBER BULK CABLE

CABLE MANAGEMENT & RACKS

INDUSTRIAL & HARSH ENVIRONMENTS



Item #	Description
207-182/500BR	Thermostat wire 18/2, 500 FT, Brown, CL2R
207-182/500WH	Thermostat wire 18/2, 500 FT, White, CL2R
207-183/500BR	Thermostat wire 18/3, 500 FT, Brown, CL2R
207-183/500WH	Thermostat wire 18/3, 500 FT, White, CL2R
207-184/250BR	Thermostat wire 18/4, 250 FT, Brown, CL2R
207-184/250WH	Thermostat wire 18/4, 250 FT, White, CL2R
207-184/500BR	Thermostat wire 18/4, 500 FT, Brown, CL2R
207-185/250BR	Thermostat wire 18/5, 250 FT, Brown, CL2R
207-185/250WH	Thermostat wire 18/5, 250 FT, White, CL2R
207-185/500BR	Thermostat wire 18/5, 500 FT, Brown, CL2R
207-186/250BR	Thermostat wire 18/6, 250 FT, Brown, CL2R
207-186/250WH	Thermostat wire 18/6, 250 FT, White, CL2R
207-186/500BR	Thermostat wire 18/6, 500 FT, Brown, CL2R
207-186/P/250WH	Thermostat wire 18/6, 250 FT, White, <b>CL2P</b>
207-188/250BR	Thermostat wire 18/8, 250 FT, Brown, CL2R
207-188/250WH	Thermostat wire 18/8, 250 FT, White, CL2R
207-188/P/250WH	Thermostat wire 18/8, 250 FT, White, <b>CL2P</b>
207-202/500BR	Thermostat wire 20/2, 500 FT, Brown, CL2R
207-204/500BR	Thermostat wire 20/4, 500 FT, Brown, CL2R

### Features:

- Class 2 power-limited circuit cable for use in thermostat control applications
- 18-20 AWG, 2-8 Conductors
- CL2R and CL2P
- Heat and moisture resistant insulation
- ETL Verified, RoHS-Compliant

### Applications:

- HVAC Systems
- Temperature Sensors
- Fire & Security Alarm Systems
- Building Automation

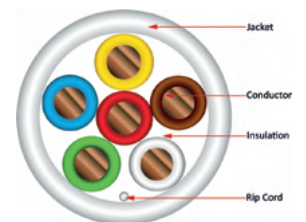
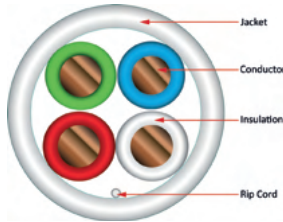
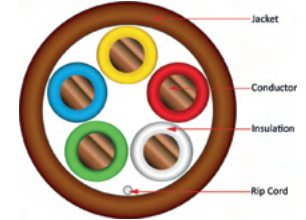
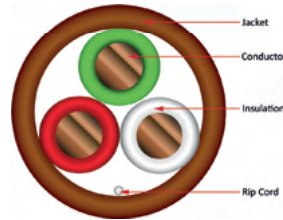
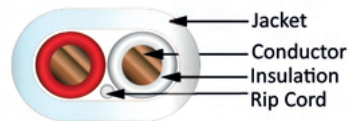

# LED Cable

## LED Cable - CL3 & Direct Burial

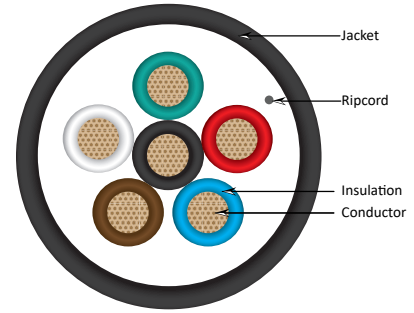
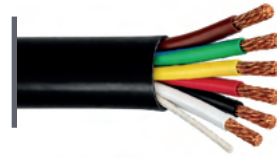

### Features:

- **CL3 rated** for in-wall residential installations
- Stranded bare copper
- Durable PVC jacket for long-term performance
- **Direct burial** rated for underground installations
- Stranded bare copper
- Resistant to water, sunlight, and soil conditions

### Item #

### Description

213-146ST/5BK	LED Cable 14/6, 500 ft, Black, <b>CL3</b> , 500 ft Spool
213-166ST/5BK	LED Cable 16/6, 500 ft, Black, <b>CL3</b> , 500 ft Spool
213-146ST/DB/5BK	LED Cable 14/6, 500 ft, Black, <b>Direct Burial</b> , 500 ft Spool

### Applications:

- Landscape and outdoor lighting
- Pathway and accent lighting
- Deck and patio lighting
- LED strip and architectural lighting
- Signage and display lighting
- Security and perimeter lighting

## From homes to businesses, VC keeps you connected.





1A-A01 1A-A02 1A-A03 1A-A04 1A-A05 1A-A06 1A-A07 1A-A08 1A-A09 1A-A10 1A-A11 1A-A12 1A-A13 1A-A14 1A-A15 1A-A16 1A-A17 1A-A18 1A-A19 1A-A20 1A-A21 1A-A22 1A-A23 1A-A24

1A-B01 1A-B02 1A-B03 1A-B04 1A-B05 1A-B06 1A-B07 1A-B08 1A-B09 1A-B10 1A-B11 1A-B12 1A-B13 1A-B14 1A-B15 1A-B16 1A-B17 1A-B18 1A-B19 1A-B20 1A-B21 1A-B22 1A-B23 1A-B24

1A-C01 1A-C02 1A-C03 1A-C04 1A-C05 1A-C06 1A-C07 1A-C08 1A-C09 1A-C10 1A-C11 1A-C12 1A-C13 1A-C14 1A-C15 1A-C16 1A-C17 1A-C18 1A-C19 1A-C20 1A-C21 1A-C22 1A-C23 1A-C24

1A-D01 1A-D02 1A-D03 1A-D04 1A-D05 1A-D06 1A-D07 1A-D08 1A-D09 1A-D10 1A-D11 1A-D12 1A-D13 1A-D14 1A-D15 1A-D16 1A-D17 1A-D18 1A-D19 1A-D20 1A-D21 1A-D22 1A-D23 1A-D24

1A-D25 1A-D26 1A-D27 1A-D28 1A-D29 1A-D30 1A-D31 1A-D32 1A-D33 1A-D34 1A-D35 1A-D36 1A-D37 1A-D38 1A-D39 1A-D40 1A-D41 1A-D42 1A-D43 1A-D44 1A-D45 1A-D46 1A-D47 1A-D48

1A-E01 1A-E02 1A-E03 1A-E04 1A-E05 1A-E06 1A-E07 1A-E08 1A-E09 1A-E10 1A-E11 1A-E12 1A-E13 1A-E14 1A-E15 1A-E16 1A-E17 1A-E18 1A-E19 1A-E20 1A-E21 1A-E22 1A-E23 1A-E24

1A-F01 1A-F02 1A-F03 1A-F04 1A-F05 1A-F06 1A-F07 1A-F08 1A-F09 1A-F10 1A-F11 1A-F12 1A-F13 1A-F14 1A-F15 1A-F16 1A-F17 1A-F18 1A-F19 1A-F20 1A-F21 1A-F22 1A-F23 1A-F24



25 26 27 28 29 30 31 32 33 34 35 36 37 38 39 40 41 42 43 44

# 1.1

**COPPER  
CONNECTIVITY**

# V-Max Keystone Jacks

## CAT6A

Item #	Description
353-V2812/C6AAL	CAT6A V-Max, Almond
353-V2813/C6ABK	CAT6A V-Max, Black
353-V2814/C6ABL	CAT6A V-Max, Blue
353-V2803/BL/25	CAT6A V-Max, 25-Pack, Blue
353-V2815/C6AGR	CAT6A V-Max, Green
353-V2816/C6AGY	CAT6A V-Max, Gray
353-V2817/C6AIV	CAT6A V-Max, Ivory
353-V2818/C6AOR	CAT6A V-Max, Orange
353-V2819/C6APR	CAT6A V-Max, Purple
353-V2820/C6ARD	CAT6A V-Max, Red
353-V2821/C6AWH	CAT6A V-Max, White
353-V2810/WH/25	CAT6A V-Max, 25-Pack, White
353-V2823/C6ABW	CAT6A V-Max, Bright White
353-V2800/BW/25	CAT6A V-Max, 25-Pack, Bright White
353-V2822/C6AYL	CAT6A V-Max, Yellow

## LIFETIME WARRANTY

## CAT6

Item #	Description
352-V2712/AL	CAT6 V-Max, Almond
352-V2701/AL/25	CAT6 V-Max, 25-Pack, Almond
352-V2713/BK	CAT6 V-Max, Black
352-V2702/BK/25	CAT6 V-Max, 25-Pack, Black
352-V2714/BL	CAT6 V-Max, Blue
352-V2703/BL/25	CAT6 V-Max, 25-Pack, Blue
352-V2715/GR	CAT6 V-Max, Green
352-V2704/GR/25	CAT6 V-Max, 25-Pack, Green
352-V2716/GY	CAT6 V-Max, Gray
352-V2705/GY/25	CAT6 V-Max, 25-Pack, Gray
352-V2717/IV	CAT6 V-Max, Ivory
352-V2706/IV/25	CAT6 V-Max, 25-Pack, Ivory
352-V2718/OR	CAT6 V-Max, Orange
352-V2707/OR/25	CAT6 V-Max, 25-Pack, Orange
352-V2719/PR	CAT6 V-Max, Purple
352-V2708/PR/25	CAT6 V-Max, 25-Pack, Purple
352-V2720/RD	CAT6 V-Max, Red
352-V2709/RD/25	CAT6 V-Max, 25-Pack, Red
352-V2723/BW	CAT6 V-Max, Bright White
352-V2700/BW/25	CAT6 V-Max, 25-Pack, Bright White
352-V2721/WH	CAT6 V-Max, White
352-V2710/WH/25	CAT6 V-Max, 25-Pack, White
352-V2722/YL	CAT6 V-Max, Yellow
352-V2711/YL/25	CAT6 V-Max, 25-Pack, Yellow



**25-Packs Available**  
(caps packed separately)

## CAT5E

Item #	Description
351-V2612/AL	CAT5E V-Max, Almond
351-V2601/AL/25	CAT5E V-Max, 25-Pack, Almond
351-V2613/BK	CAT5E V-Max, Black
351-V2602/BK/25	CAT5E V-Max, 25-Pack, Black
351-V2614/BL	CAT5E V-Max, Blue
351-V2603/BL/25	CAT5E V-Max, 25-Pack, Blue
351-V2615/GR	CAT5E V-Max, Green
351-V2604/GR/25	CAT5E V-Max, 25-Pack, Green
351-V2616/GY	CAT5E V-Max, Gray
351-V2605/GY/25	CAT5E V-Max, 25-Pack, Gray
351-V2617/IV	CAT5E V-Max, Ivory
351-V2606/IV/25	CAT5E V-Max, 25-Pack, Ivory
351-V2618/OR	CAT5E V-Max, Orange
351-V2607/OR/25	CAT5E V-Max, 25-Pack, Orange
351-V2619/PR	CAT5E V-Max, Purple
351-V2608/PR/25	CAT5E V-Max, 25-Pack, Purple
351-V2620/RD	CAT5E V-Max, Red
351-V2609/RD/25	CAT5E V-Max, 25-Pack, Red
351-V2621/WH	CAT5E V-Max, White
351-V2610/WH/25	CAT5E V-Max, 25-Pack, White
351-V2622/YL	CAT5E V-Max, Yellow
351-V2611/YL/25	CAT5E V-Max, 25-Pack, Yellow

## CAT3

Item #	Description
350-V2506/IV	CAT3 Jack, Ivory
350-V2510/WH	CAT3 Jack, White



Almond



Black



Blue



Green



Gray



Ivory



Orange



Purple



Red



Bright White



White



Yellow

## Compare Bright White, White, Gray, Ivory and Almond colors:



Bright White

White

Gray

Ivory

Almond

CAT3

CAT5E

CAT6

CAT6A

Features:



- Color-coded for T568A and T568B wiring
- Supports PoE Type 1, Type 2, Type 3, and Type 4
- Fits standard keystone wall plates and patch panels
- UL listed and RoHS compliant

## I-Punch Tool

078-2150

## Time-Saving Solution by Vertical Cable: Terminate V-Max Jacks in Seconds

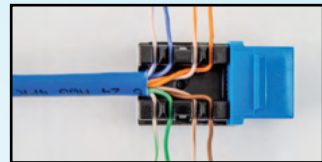
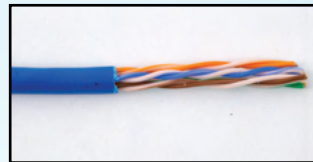
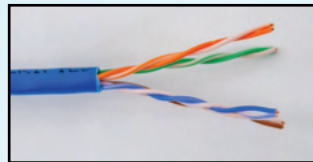

Strip up to 2 inches of cable jacket. Separate the pairs and maintain twists as close to the point of termination as possible. Select T568A or T568B and align conductors accordingly. Keep the cable jacket close to the connector.

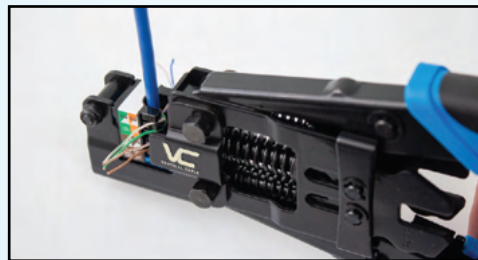

Insert the prepared jack and cable assembly into the I-Punch Tool.

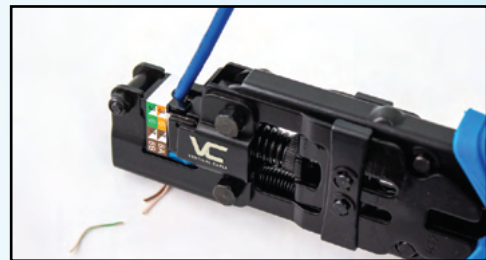

Firmly squeeze the handles, release, and repeat to ensure a complete termination.

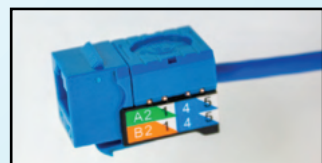
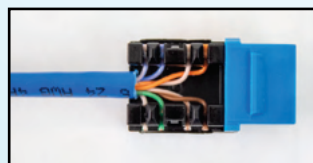

Cleanly trimmed conductors. Snap on the cap. Termination complete.

**L I F E T I M E W A R R A N T Y**

# Keystone Couplers

COPPER BULK CABLE

OPTICAL FIBER BULK CABLE

CABLE MANAGEMENT & RACKS

INDUSTRIAL & HARSH ENVIRONMENTS

## CAT6A, CAT6, CAT5E RJ45 Keystone Couplers - Unshielded

302-KCJ/BK



Front



Back

301-KCJ/BL



302-KCJ/WH



### Features:

- o Universal snap-in fit for keystone openings
- o Quick-install design with flexible locking tab
- o Gold-plated contacts for consistent signal integrity
- o Durable housing for dependable, long-term use
- o Compatible with standard patch panels and wall plates



Item #	Description
303-KCJ/C6A/BK	CAT6A Keystone Coupler, Unshielded, Black
302-KCJ/BK	CAT6 Keystone Coupler, Unshielded, Black
302-KCJ/WH	CAT6 Keystone Coupler, Unshielded, White
302-KCJ/BL	CAT6 Keystone Coupler, Unshielded, Blue
301-KCJ/BK	CAT5E Keystone Coupler, Unshielded, Black
301-KCJ/BL	CAT5E Keystone Coupler, Unshielded, Blue

## CAT6A RJ45 Keystone Couplers - Shielded



Item #	Description
303-KCJ/S	CAT6A Keystone Coupler, Shielded

## V-Max Jacks - Shielded



### Features:

- o Supports T568A and T568B wiring schemes
- o Flexible tab design for quick installation
- o Meets or exceeds ANSI/TIA-568.2-D standards
- o 360-degree shielding to minimize EMI
- o 110-type IDC termination
- o UL listed and RoHS compliant
- o Includes cable tie for secure termination

Item #	Description
303-J2637/C6AS	CAT6A Shielded Jack
302-J2631/S	CAT6 Shielded Jack
301-J2630/S	CAT5E Shielded Jack

Compatible with all blank Vertical Cable Patch Panels (except for 1 RMU 48-port 266-PKM02-D8000)

### Related products:



[078-2155/S](#)

P80



[078-1025](#)

P80

## RJ45 Inline Couplers - CAT6A, CAT6, CAT5E

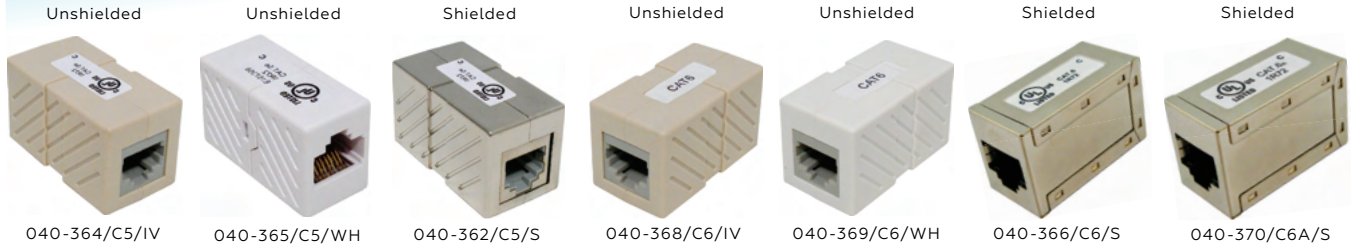

### Features:

- o RJ45 female-to-female inline coupler
- o Extends Ethernet cable connections
- o Available in shielded and unshielded versions
- o Compact design for easy installation
- o UL listed, ETL listed, and RoHS compliant



Item #	Description
040-3705/C6A/WH	CAT6A RJ45 inline Coupler Extension, White
040-370/C6A/S	CAT6A RJ45 inline Coupler Extension, Shielded
040-369/C6/WH	CAT6 RJ45 inline Coupler Extension, White
040-368/C6/IV	CAT6 RJ45 inline Coupler Extension, Ivory
040-366/C6/S	CAT6 RJ45 inline Coupler Extension, Shielded
040-365/C5/WH	CAT5E RJ45 inline Coupler Extension, White
040-364/C5/IV	CAT5E RJ45 inline Coupler Extension, Ivory
040-362/C5/S	CAT5E RJ45 inline Coupler Extension, Shielded

## Junction Boxes - CAT6, CAT5E



### Features:

- o Compatible with 110 type termination tools
- o Supports T568A and T568B wiring schemes
- o Includes screws and adhesive mounting tape
- o Fire-retardant housing for added safety
- o Durable high-impact ABS construction
- o Suitable for 22–26 AWG solid wire
- o Available in shielded and unshielded versions

Item #	Description
040-374/C6J/S	CAT6 Shielded Junction Box, T568A and T568B Standards, Compatible with 110 Termination tools
040-372/C6J/WH	CAT6 Junction Box, White, T568A and T568B Standards, Compatible with 110 Termination tools
040-373/C5J/S	CAT5E Shielded Junction Box, T568A and T568B Standards, Compatible with 110 Termination tools
040-371/C5J/WH	CAT5E Junction Box, White, T568A and T568B Standards, Compatible with 110 Termination tools



VERTICAL CABLE

**Perfect  
Color Match.**  
Seamless Finish.

---

*Designed to blend in —  
so your installation  
stands out.*

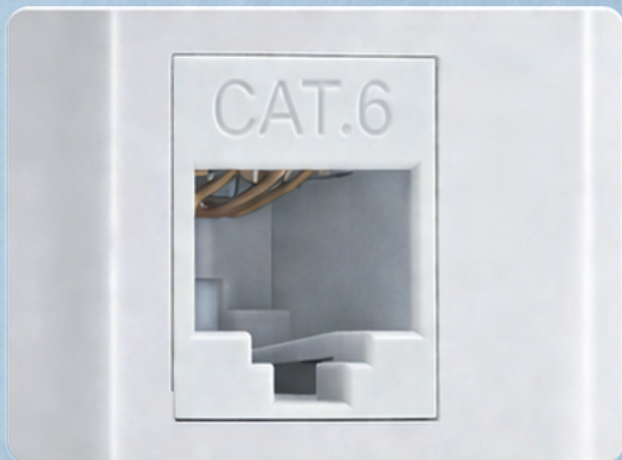

## Keystone Wall Plates

### Decora Style Wall Plates



#### Features:

- Decora-style, single-gang design
- Available in 0, 1, 2, 3, 4, and 6-port options
- Compatible with standard keystone inserts
- High-impact ABS construction
- UL 94 V-0 flame-retardant rated
- Smooth, low-gloss finish
- Includes color-matched mounting screws

# of Ports	Item #	Description
0	308-603D/0P/WH	Keystone Wall Plate, 0-Port, Decora Style
1	308-607D/1P/WH	Keystone Wall Plate, 1-Port, Decora Style
2	308-611D/2P/WH	Keystone Wall Plate, 2-Port, Decora Style
3	308-615D/3P/WH	Keystone Wall Plate, 3-Port, Decora Style
4	308-619D/4P/WH	Keystone Wall Plate, 4-Port, Decora Style
6	308-623D/6P/WH	Keystone Wall Plate, 6-Port, Decora Style

### Standard Wall Plates



# of Ports	Almond	Black	Ivory	White	Gray
(0) Blank	304-J2628/0P/AL	N/A	304-J2629/0P/IV	304-J2630/0P/WH	304-J2660/0P/GY
1 Port	304-J2631/1P/AL	304-J2646/1P/BK	304-J2632/1P/IV	304-J2633/1P/WH	304-J2661/1P/GY
2 Port	304-J2634/2P/AL	304-J2647/2P/BK	304-J2635/2P/IV	304-J2636/2P/WH	304-J2662/2P/GY
3 Port	304-J2637/3P/AL	304-J2648/3P/BK	304-J2638/3P/IV	304-J2639/3P/WH	N/A
4 Port	304-J2640/4P/AL	304-J2649/4P/BK	304-J2641/4P/IV	304-J2642/4P/WH	304-J2664/4P/GY
6 Port	304-J2643/6P/AL	N/A	304-J2644/6P/IV	304-J2645/6P/WH	304-J2665/6P/GY
8 Port	N/A	N/A	N/A	304-2803/8P/WH	N/A
12 Port	N/A	N/A	N/A	304-2806/12P/WH	N/A



# Junction Boxes, Dry Wall Brackets, Feedthrough Wall Plates

COPPER BULK CABLE

OPTICAL FIBER BULK CABLE

CABLE MANAGEMENT & RACKS

INDUSTRIAL & HARSH ENVIRONMENTS

## Surface-mount Mounting Boxes

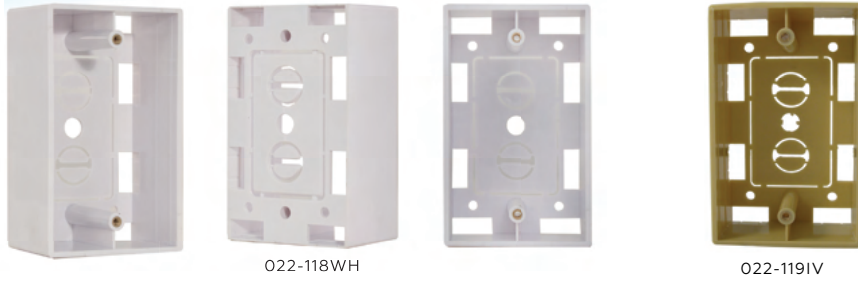

Illustration of a loaded wall plate mounted on the junction box



Item #	Description
022-117WH/D	Single Gang Junction Box, White 2.75(W)x4.5(H)x1.85(D)
022-118WH	Single Gang Junction Box, White 2.75(W)x4.5(H)x1.5(D)
022-119IV	Single Gang Junction Box, Ivory 2.75(W)x4.5(H)x1.5(D)

## Dry-Wall Brackets



Item #	Description
022-DWB/1G	Single Gang Dry Wall Bracket for US Type Face Plate – Low Voltage Class 2
022-DWB/2G	Double Gang Dry Wall Bracket for US Type Face Plate – Low Voltage Class 2
022-MB/1G	Single Gang Mounting Bracket, Nail-on, Low Voltage Class 2
022-MB/2G	Double Gang Mounting Bracket, Nail-on, Low Voltage Class 2

## Feedthrough Wall Plates



### Features:

- High-impact ABS construction
- Comes with matching-color mounting screws
- Smooth finish



Item #	Description
307-503F/1G/WH	Feedthrough Wall Plate, Single Gang
307-507F/2G/WH	Feedthrough Wall Plate, Double Gang
307-511R/1G/WH	Feedthrough Recessed Wall Plate, Single Gang
307-515R/2G/WH	Feedthrough Recessed Wall Plate, Double Gang
307-520B/1G/WH	Feedthrough Wall Plate Brush Type, Decora Style

# Keystone Wall Plates

## Standard Wall Plates - Stainless Steel



### Features:

- Standard size, Single Gang
- Stainless steel brushed finish
- High-impact ABS Base

Item #	Description
304-J2651/0P/S	Stainless Steel Wall Plate, 0 Port
304-J2652/1P/S	Stainless Steel Wall Plate, 1 Port
304-J2653/2P/S	Stainless Steel Wall Plate, 2 Port
304-J2654/3P/S	Stainless Steel Wall Plate, 3 Port
304-J2655/4P/S	Stainless Steel Wall Plate, 4 Port



## Mid-size Wall Plates

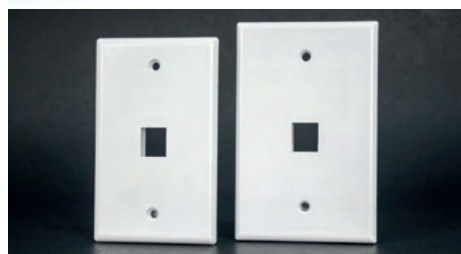

Standard 2,78" x 4,5"  
Mid-size 3,15" x 4,88"

# of Ports	Item #	Description
0	304-M2725/0P/WH	Keystone Mid Size Wall Plate, 0-Port, White
1	304-M2726/1P/WH	Keystone Mid Size Wall Plate, 1-Port, White
2	304-M2727/2P/WH	Keystone Mid Size Wall Plate, 2-Port, White
3	304-M2728/3P/WH	Keystone Mid Size Wall Plate, 3-Port, White
4	304-M2729/4P/WH	Keystone Mid Size Wall Plate, 4-Port, White
6	304-M2730/6P/WH	Keystone Mid Size Wall Plate, 6-Port, White

## Standard Wall Plate with ID Window



305-306ID/1P/IV

305-311ID/2P/WH

305-314ID/3P/IV

305-319ID/4P/WH

305-322ID/6P/IV

### Features:

- High-impact ABS construction
- Comes with matching-color mounting screws
- Smooth finish
- Available in Ivory and White

# of Ports	Ivory	White
	1 Port	305-306ID/1P/IV
2 Port	305-310ID/2P/IV	305-311ID/2P/WH
3 Port	305-314ID/3P/IV	305-315ID/3P/WH
4 Port	305-318ID/4P/IV	305-319ID/4P/WH
6 Port	305-322ID/6P/IV	305-323ID/6P/WH



# Surface Mount Boxes

## 1, 2, 4 and 6 Ports - Blank



039-358WH



1-Port

Includes:



Double-sided tape, screws, cable tie

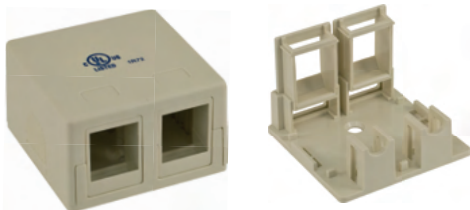

039-359AL



2-Port

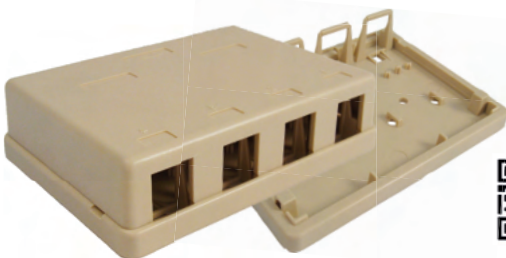

039-362IV



4-Port

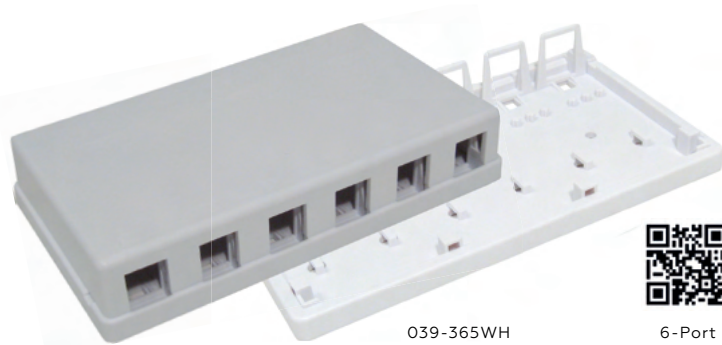

039-365WH



6-Port

### Features:

- Surface-mount box, 1–6 ports
- Keystone compatible (unpopulated)
- Includes mounting hardware
- Two-piece design
- Multiple color options
- UL-listed, RoHS-compliant



Item #	Description
039-356AL	1-Port, Surface Mount Box, Almond
039-357IV	1-Port, Surface Mount Box, Ivory
039-358WH	1-Port, Surface Mount Box, White
039-359AL	2-Port, Surface Mount Box, Almond
039-360IV	2-Port, Surface Mount Box, Ivory
039-361WH	2-Port, Surface Mount Box, White
039-362IV	4-Port, Surface Mount Box, Ivory
039-362WH	4-Port, Surface Mount Box, White
039-364IV	6-Port, Surface Mount Box, Ivory
039-365WH	6-Port, Surface Mount Box, White

## Snack on this: The "biscuit" is the cleanest way to finish a run

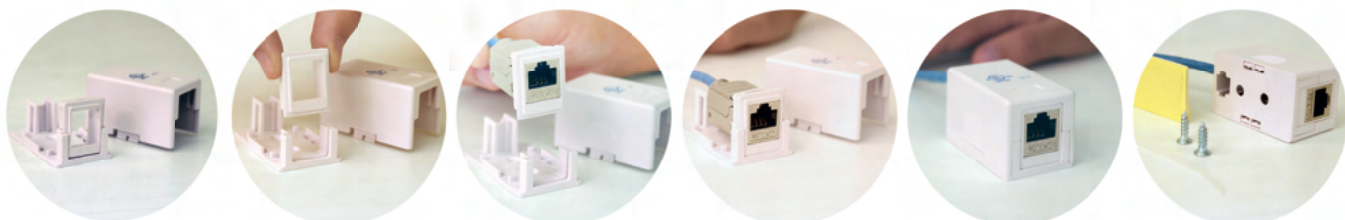

# 1 and 2 Ports - With Jacks

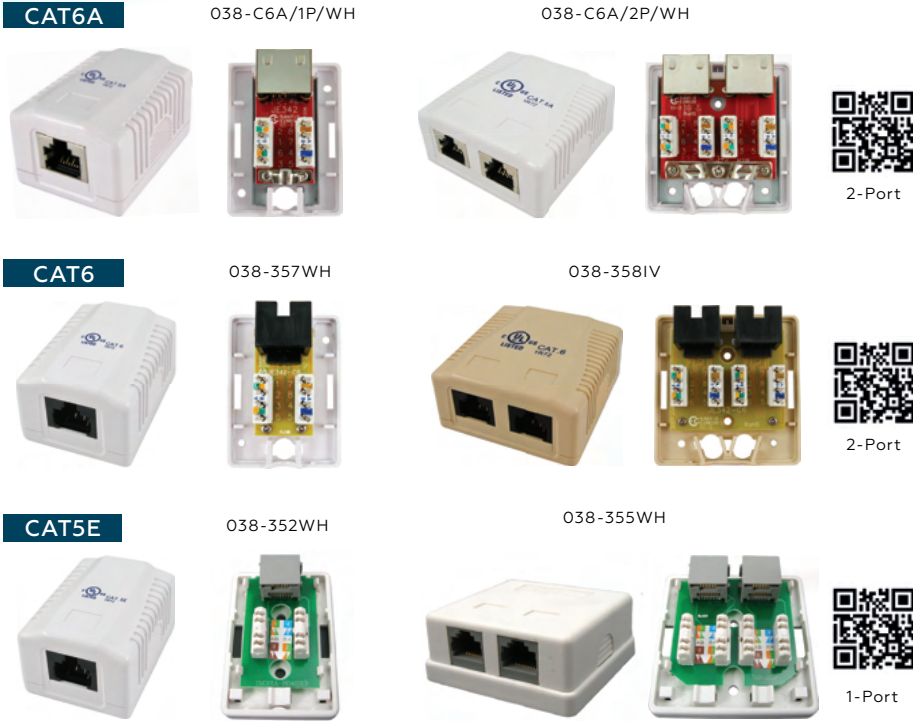

Includes:



Double-sided tape, screws, cable tie

**Features:**

- Durable ABS construction
- Includes mounting hardware
- Gloss finish
- Integrated 110-type termination blocks
- Shielded construction for CAT6A applications
- UL 94 V-0 flame rated and UL-listed

Item #	Description
038-C6A/1P/WH	1-Port SMB, Shielded with CAT6A Jack, White
038-C6A/2P/WH	2-Port SMB, Shielded with CAT6A Jack, White
038-356IV	1-Port SMB with CAT6 Jack, Ivory
038-357WH	1-Port SMB with CAT6 Jack, White
038-358IV	2-Port SMB with CAT6 Jack, Ivory
038-359WH	2-Port SMB with CAT6 Jack, White
038-351IV	1-Port SMB with CAT5E Jack, Ivory
038-352WH	1-Port SMB with CAT5E Jack, White
038-354IV	2-Port SMB with CAT5E Jack, Ivory
038-355WH	2-Port SMB with CAT5E Jack, White



**Related Products:**

[Patch cords](#) P74



093-695/1YL



076-1053/7WH



077-2089/14WH

[Keystone couplers](#) P56



302-KJC/BL

[Impact Punch Down Too](#) P80



078-1025

# Patch Panels

## CAT6A Patch Panel, 24 Port



Cable Management Bars **P127**



Item #	Description
042-381/U6A/24	CAT6A, 110-IDC Patch Panel, 24 Port, Black



## CAT6 and CAT5E Patch Panels, 12, 24, 48 & 96 Port

042-376/12 / 041-371/12



042-377/24 / 041-372/24



042-378/48 / 041-373/48



041-375/96



### CAT6

Item #	Description
042-376/12	CAT6, 110-IDC Patch Panel, 12 Port, Black
042-377/24	CAT6, 110-IDC Patch Panel, 24 Port, Black
042-378/48	CAT6, 110-IDC Patch Panel, 48 Port, Black

### CAT5E

Item #	Description
041-371/12	CAT5E, 110-IDC Patch Panel, 12 Port, Black
041-372/24	CAT5E, 110-IDC Patch Panel, 24 Port, Black
041-373/48	CAT5E, 110-IDC Patch Panel, 48 Port, Black
041-375/96	CAT5E, 110-IDC Patch Panel, 96 Port, Black

**Port Spacing**  
 0.72 in (Brother label printer)  
 0.71 in (Epson label printer)

### Features:

- o High Impact Patch Panel
- o Number Labeled for Easy Identification
- o 110 Type Termination

## 12 Port Surface-Mount Mini Patch Panels - CAT6, CAT5E & Blank

front

rear



042-2134

041-370M

043-381/12M

### Features:

#### Loaded:

- o High Impact Patch Panel
- o Number Labeled for Easy Identification
- o 110 Type Termination

#### Blank:

- o Compatible with most keystone inserts



Item #	Description
042-2134	<b>CAT6</b> , 110-IDC 12 Port Mini Patch Panel, with Support Bracket, Black
041-370M	<b>CAT5E</b> , 110-IDC 12 Port Mini Patch Panel, with Support Bracket, Black
043-381/12M	<b>Blank</b> Mini Patch Panel, 12 Port, with Support Bracket, Black

## Patch Panels

### CAT6A, CAT6 Shielded Patch Panels



24 Port



48 Port

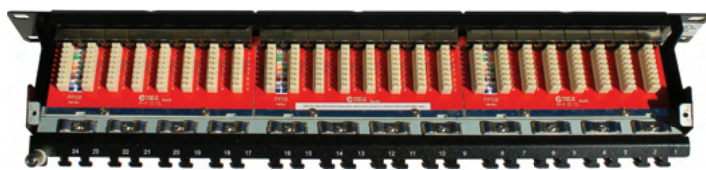

Try our Vertical Wall-Mount Brackets, 1-4 RMU

**047-WVR Series**

P128

Item #	Description
042-C6A/24	CAT6A, Shielded 24 Port, Krone Type, Patch Panel   1 RMU
042-C6A/48	CAT6A, Shielded 48 Port, Krone Type, Patch Panel   1 RMU
042-377/S/24	CAT6, Shielded Krone type Patch Panel, 24 Port, Black
042-378/S/48	CAT6, Shielded Krone type Patch Panel, 48 Port, Black



### CAT5E Shielded Patch Panel, 24 & 48 Port



24 Port



48 Port



#### Features:

- Meets or exceeds ANSI/TIA-568-2-D specifications
- T568A/T568B wiring scheme
- Grounding wire: 18 AWG wire with Green/Yellow stripes, length 15.7 in (40 cm).



Item #	Description
041-372/S/24	CAT5E, Shielded Krone type Patch Panel, 24 Port, Black
041-373/S/48	CAT5E, Shielded Krone type Patch Panel, 48 Port, Black

Comes with M6 screws, mini-cable-ties & grounding wire



Screws

P127

Compatible tool: 078-1025

P80



## Patch Panels » BLANK PATCH PANELS

**Blank Keystone Patch Panels - Shielded Insert Compatible**

Item #	Description
043-378/S/24/1U	Blank Keystone Patch Panel, 24 Port, Shielded Insert Compatible
043-379/S/48/2U	Blank Keystone Patch Panel, 48 Port, Shielded Insert Compatible

**Features:**

- Heavy-duty 16-gauge steel construction
- UL94 V-0 fire-retardant rated
- Integrated grounding with drain wire
- Durable black powder-coated finish

**Blank Keystone Patch Panels**

Item #	Description
043-382/24/1U	Blank Keystone Patch Panel, with Cable Manager, 1 RMU, 24 Port, Black
043-384/48/2U	Blank Keystone Patch Panel, with Cable Manager, 2 RMU, 48 Port, Black

**Features:**

- Heavy-duty 16-gauge steel construction
- UL94 V-0 fire-retardant material
- Cable manager included
- Durable black powder-coated finish

**Blank Panels are compatible with most VC keystone inserts:**

303-J2637/C6AS



303-KCJ/S



352-V2714/BL



303-KCJ/C6A/BK



## Blank V-Type Panels



Item #	Description
043-383/A/24	Blank Patch Panel, V-Type, 24 Port
043-384/A/48	Blank Patch Panel, V-Type, 48 Port

**Features:**

- o Heavy-duty 16-gauge steel construction
- o UL94 V-0 fire-retardant material
- o V-type design for improved cable management

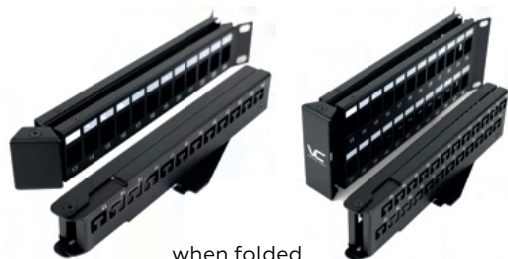

## Blank Keystone Patch Panels - Standard Density



**1 RMU**

<a href="#">Keystone Modules</a>	<a href="#">P56</a>
----------------------------------	---------------------

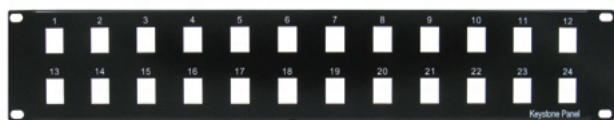

**2 RMU**

<a href="#">V-Max Keystone Jacks</a>	<a href="#">P31</a>
--------------------------------------	---------------------

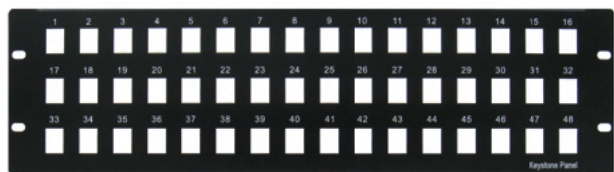

**3 RMU**

<a href="#">Patch Cords</a>	<a href="#">P48</a>
-----------------------------	---------------------

<a href="#">Racks</a>	<a href="#">P118</a>
-----------------------	----------------------



**Features:**

- o Constructed from heavy-duty 16-gauge steel and UL94-V-0 high-impact, fire-retardant material
- o Durable black powder coat finish
- o 4 x M6 screws

Item #	Description
043-380/12	Blank Patch Panel, 12 Port, Black
043-382/24	Blank Patch Panel, 24 Port, Black
043-384/48	Blank Patch Panel, 48 Port, Black



037-321GY



037-328BK



264-KMB03-4C-WH



245-KJC/FF/180

## Patch Panels » BLANK PATCH PANELS

## Blank Keystone Patch Panels - Unshielded Panels

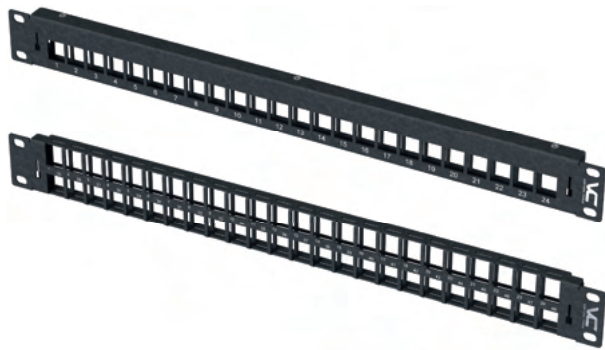

Item #	Description
266-PKM02-24000	Blank Patch Panel, <b>24 Port</b> , 1 RMU
266-PKM02-D8000	Blank Patch Panel, <b>48 Port</b> , 1 RMU - High Density Panel

Cable Manager not included

[Keystone Jacks](#)

P54

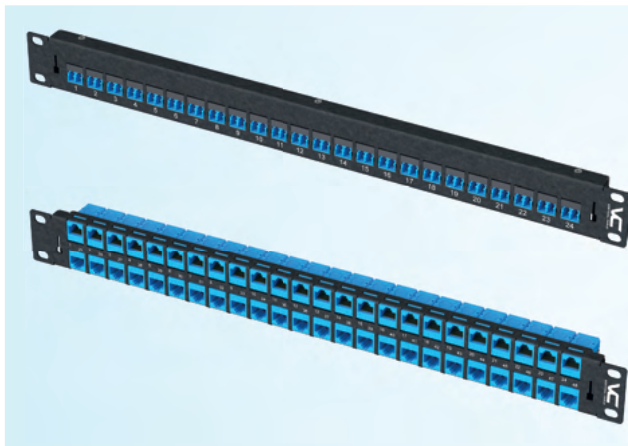
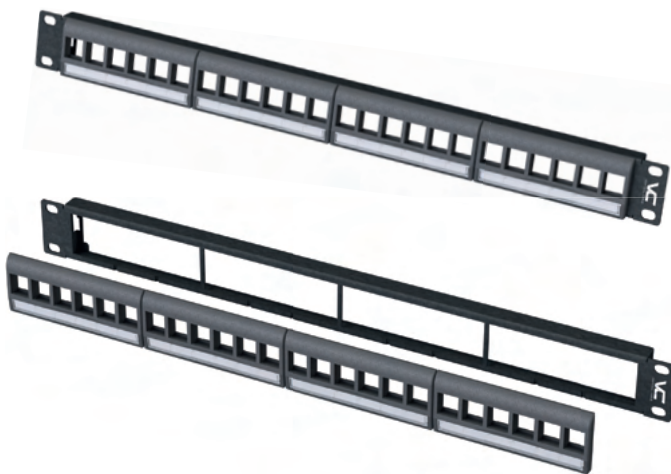

Illustration of a 24-port panel loaded with fiber connectors

Illustration of a 48-port panel loaded with keystone jacks



Item #	Description
266-PKM04-24000	Blank Patch Panel, <b>Front-Retractable</b> Keystone-Module Blocks, 1 RMU, <b>24 Port</b> , Black

Cable Manager not included

## Features:

- Universal Mounting Standard
- Durable Construction
- Black Powder Coating Finishing
- Integrated Labeling System
- Front Pull-Out Module Blocks

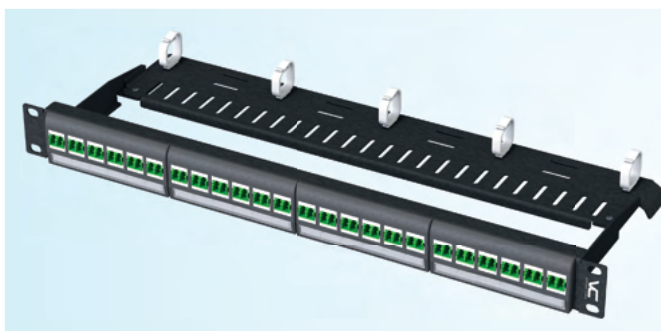

Illustration of a 48-port panel loaded with fiber connectors and one cable management bar

## Cable Management Bars for 266-PKM Series Panels



266-CFM00-2A3



266-CFM00-2A4



266-CFM00-2B3

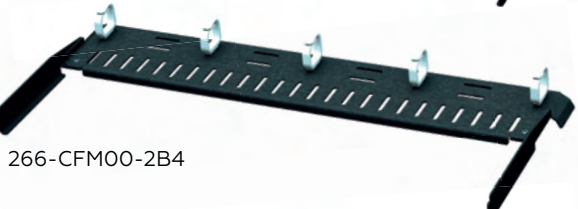

266-CFM00-2B4



266-CFM00-2A2A

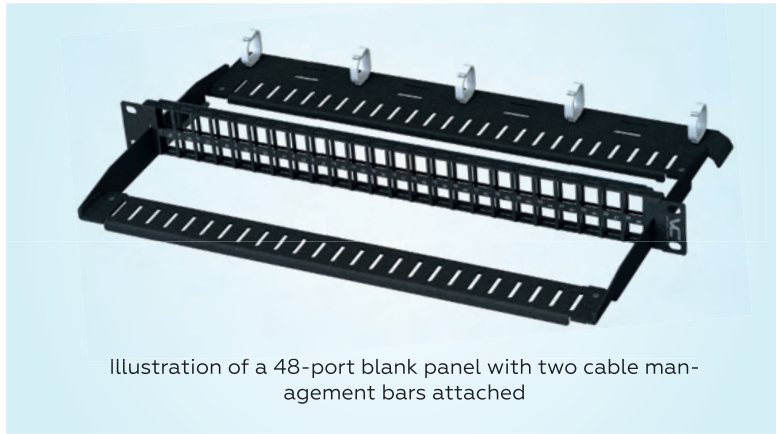

Illustration of a 48-port blank panel with two cable management bars attached

Item #	Description
266-CFM00-2A3	Cable Management Bar, General Purpose, 3-in Depth
266-CFM00-2A4	Cable Management Bar, General Purpose, 4-in Depth
266-CFM00-2B3	Cable Management Bar, Optical Fiber, 3-in Depth
266-CFM00-2B4	Cable Management Bar, Optical Fiber, 4-in Depth
266-CFM00-2A2A	Cable Management Bar, 2-in Deep, Extended Width



## Rack-Mount Identification and Labeling

### Zero-U Administration Panels



266-LBL00-A1A4A

4x label holders are included with panel



266-LBL00-A0A4A



266-LBL04-HLDR



266-LBL03-HLDR

Item #	Description
266-LBL00-A0A4A	Administration Panel, Zero-U, <b>Rack-Mount</b>
266-LBL00-A1A4A	Administration Panel, Zero-U, <b>Panel-Mount</b>
266-LBL04-HLDR	Quarter Label, <b>4x</b> label holders per kit
266-LBL03-HLDR	Third Label Holders, <b>3x</b> label holders per kit



# Panel Covers

COPPER BULK CABLE

OPTICAL FIBER BULK CABLE

CABLE MANAGEMENT & RACKS

INDUSTRIAL & HARSH ENVIRONMENTS

## Blank Filler Panels - Vented and Non-vented

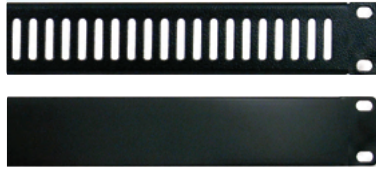

### 1 RMU

Height 13/4 in Width 19 in Depth 0.5 in Weight 1 lb

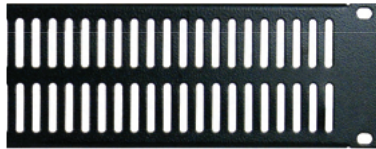

### 2 RMU

Height 3.5 in Width 19 in Depth 0.5 in Weight 2 lb



### 3 RMU

Height 5.1/4 in Width 19 in Depth 0.5 in Weight 2 lb



### 4 RMU

Height 6.7/8 in Width 19 in Depth 0.5 in Weight 2.4 lb



### Vented Filler Panels

Item #	Description
043-385/VT/1U	1 RMU, Vented Panel Cover/Filler 19 in Rack Mountable
043-386/VT/2U	2 RMU, Vented Panel Cover/Filler 19 in Rack Mountable
043-387/VT/3U	3 RMU, Vented Panel Cover/Filler 19 in Rack Mountable

#### Features:

- Mounts on any standard 19-in rack hardware
- Vented for allowing air circulation and improving lighting conditions
- Made of 1.5-mm steel
- Impact and static-resistant black paint finish



### Non-Vented Filler Panels

Item #	Description
043-385/1U	1 RMU, Non-Vented Panel Cover/Filler 19 in Rack Mountable
043-386/2U	2 RMU, Non-Vented Panel Cover/Filler 19 in Rack Mountable
043-387/3U	3 RMU, Non-Vented Panel Cover/Filler 19 in Rack Mountable
043-388/4U	4 RMU, Non-Vented Panel Cover/Filler 19 in Rack Mountable

#### Features:

- Mounts on any standard 19-in rack hardware
- Made of 1.5-mm steel
- Impact and static-resistant black paint finish
- Improves cooling efficiency by isolating air flows, provides installation with a clean, aesthetic appearance

Hardware:  
4x M6 screws



## Cable Management Brush Panels



### 1 RMU

Height 1.8 in Width 19 in Depth 0.4 in Weight 1.2 lb



### 2 RMU

Height 3.5 in Width 19 in Depth 0.4 in Weight 1.2 lb

Item #	Description
047-WBP-1000	1 RMU Network Brush Panel, 19 in Rack Mount
047-WBP-2000	2 RMU Network Brush Panel, 19 in Rack Mount

#### Features:

- High density nylon brush
- Reduces dust penetration into protected space



**VC**  
VERTICAL CABLE

# Patch Cords

COPPER BULK CABLE

TYPE / CATEGORY	CAT6A	CAT6	CAT5E
<b>Shielded</b>	<b>076 Series</b> 0.5, 1, 3, 5, 7, 10, 14, 25 FT	-	-
<b>Unshielded with Protector</b>	<b>077 Series (Slim)</b> 0.5, 1, 2, 3, 5, 7, 10, 14, 25, 50 FT	<b>094 Series</b> 0.5, 1, 2, 3, 4, 5, 6, 7, 10, 14, 20, 25, 35, 50, 75, 100 FT	<b>092 Series</b> 0.5, 1, 2, 3, 4, 5, 6, 7, 10, 14, 20, 25, 35, 50, 75, 100 FT
<b>Unshielded without Protector</b>	-	<b>095 Series</b> 1, 3, 5, 6, 7, 10, 14, 25 FT	<b>093 Series</b> 1, 3, 5, 7, 10, 14, 25 FT

OPTICAL FIBER BULK CABLE

## CAT6A Patch Cords: S/STP (Shielded/Foiled Twisted Pair) with Boot and Protector



Size	Black	Blue	Green	Gray	Red	White	Yellow
1/2 FT	076-1002/05BK	076-1001/05BL	076-1003/05GR	076-1004/05GY	Special Order	076-1008/05WH	Special Order
1 FT	076-1010/1BK	076-1011/1BL	076-1012/1GR	076-1013/1GY	076-1016/1RD	076-1017/1WH	076-1018/1YL
3 FT	076-1028/3BK	076-1029/3BL	076-1030/3GR	076-1031/3GY	076-1034/3RD	076-1035/3WH	076-1036/3YL
5 FT	076-1037/5BK	076-1038/5BL	076-1039/5GR	076-1040/5GY	076-1043/5RD	076-1044/5WH	076-1045/5YL
7 FT	076-1046/7BK	076-1047/7BL	076-1048/7GR	076-1049/7GY	076-1052/7RD	076-1053/7WH	076-1054/7YL
10 FT	076-1055/10BK	076-1056/10BL	076-1057/10GR	076-1058/10GY	076-1061/10RD	076-1062/10WH	076-1063/10YL
14 FT	076-1064/14BK	076-1065/14BL	076-1066/14GR	076-1067/14GY	076-1070/14RD	076-1071/14WH	076-1072/14YL
25 FT	076-1073/25BK	076-1074/25BL	076-1075/25GR	076-1076/25GY	076-1079/25RD	076-1080/25WH	076-1081/25YL

### Features:

- o CAT6A transmission performance
- o Supports PoE Type 2 IEEE 802.3at (25.5W)
- o Flame-retardant PVC jacket
- o Gold-plated contacts
- o UL-listed and RoHS-Compliant
- o 4 pairs of 24-AWG stranded insulated bare copper conductors



Shielded Keystone Jacks P56

CABLE MANAGEMENT & RACKS



INDUSTRIAL & HARSH ENVIRONMENTS

## Patch Cords

# CAT6A Patch Cords: UTP with Protector (Slim Type)



Size	Black	Blue	Green	Gray	Orange	Purple	Red	White	Yellow
1/2 FT	077-2010/05BK	077-2011/05BL	077-2012/05GR	077-2013/05GY	077-2014/05OR	077-2015/05PR	077-2016/05RD	077-2017/05WH	077-2018/05YL
1 FT	077-2019/1BK	077-2020/1BL	077-2021/1GR	077-2022/1GY	077-2023/1OR	077-2024/1PR	077-2025/1RD	077-2026/1WH	077-2027/1YL
2 FT	077-2028/2BK	077-2029/2BL	077-2030/2GR	077-2031/2GY	077-2032/2OR	077-2033/2PR	077-2034/2RD	077-2035/2WH	077-2036/2YL
3 FT	077-2037/3BK	077-2038/3BL	077-2039/3GR	077-2040/3GY	077-2041/3OR	077-2042/3PR	077-2043/3RD	077-2044/3WH	077-2045/3YL
5 FT	077-2046/5BK	077-2047/5BL	077-2048/5GR	077-2049/5GY	077-2050/5OR	077-2051/5PR	077-2052/5RD	077-2053/5WH	077-2054/5YL
7 FT	077-2064/7BK	077-2065/7BL	077-2066/7GR	077-2067/7GY	077-2068/7OR	077-2069/7PR	077-2070/7RD	077-2071/7WH	077-2072/7YL
10 FT	077-2073/10BK	077-2074/10BL	077-2075/10GR	077-2076/10GY	077-2077/10OR	077-2078/10PR	077-2079/10RD	077-2080/10WH	077-2081/10YL
14 FT	077-2082/14BK	077-2083/14BL	077-2084/14GR	077-2085/14GY	077-2086/14OR	077-2087/14PR	077-2088/14RD	077-2089/14WH	077-2090/14YL
25 FT	077-2100/25BK	077-2101/25BL	077-2102/25GR	077-2103/25GY	077-2104/25OR	077-2105/25PR	077-2106/25RD	077-2107/25WH	077-2108/25YL
50 FT	077-2109/50BK	077-2110/50BL	Special Order	Special Order	Special Order	Special Order	Special Order	077-2116/50WH	Special Order

## 6-inch Patch Cords are Available in 24-Packs

Item #	Description
077-3000/05BK24	CAT6A Slim patch cord, 6-in, 28 AWG, PoE Type 2, 24-pack, Black
077-3001/05BL24	CAT6A Slim patch cord, 6-in, 28 AWG, PoE Type 2, 24-pack, Blue
077-3002/05GR24	CAT6A Slim patch cord, 6-in, 28 AWG, PoE Type 2, 24-pack, Green
077-3003/05GY24	CAT6A Slim patch cord, 6-in, 28 AWG, PoE Type 2, 24-pack, Gray
077-3004/05OR24	CAT6A Slim patch cord, 6-in, 28 AWG, PoE Type 2, 24-pack, Orange
077-3005/05PR24	CAT6A Slim patch cord, 6-in, 28 AWG, PoE Type 2, 24-pack, Purple
077-3006/05RD24	CAT6A Slim patch cord, 6-in, 28 AWG, PoE Type 2, 24-pack, Red
077-3007/05WH24	CAT6A Slim patch cord, 6-in, 28 AWG, PoE Type 2, 24-pack, White
077-3008/05YL24	CAT6A Slim patch cord, 6-in, 28 AWG, PoE Type 2, 24-pack, Yellow



### Highlights:

- Ultra-slim profile improves airflow in racks and cabinets
- Ideal for high-density, clean, and organized installations
- Multiple colors & lengths available
- Supports PoE+ (Type 2)
- Exact-length design

**Ultra-Slim. High Density.  
Clean Installations.**



### Features:

- CAT6A transmission performance
- CM-Rated
- PoE Type 2 IEEE 802.3at (25.5W)
- Flame-retardant PVC jacket
- Gold-plated contacts
- RoHS-Compliant
- 4 pairs of 28-AWG stranded insulated bare copper conductors



## Patch Cords

### CAT6 Patch Cords - UTP Non-Booted



Size	Black	Blue	Green	Gray	Red	White	Yellow
1 FT	095-903/1BK	095-904/1BL	095-905/1GR	095-906/1GY	095-909/1RD	095-910/1WH	095-911/1YL
2 FT	095-912/2BK	095-913/2BL	095-914/2GR	095-915/2GY	095-918/2RD	095-919/2WH	095-920/2YL
3 FT	095-921/3BK	095-922/3BL	095-923/3GR	095-924/3GY	095-927/3RD	095-928/3WH	095-929/3YL
5 FT	095-930/5BK	095-931/5BL	095-932/5GR	095-933/5GY	095-936/5RD	095-937/5WH	095-938/5YL
7 FT	095-939/7BK	095-940/7BL	095-941/7GR	095-942/7GY	095-945/7RD	095-946/7WH	095-947/7YL
10 FT	095-948/10BK	095-949/10BL	095-950/10GR	095-951/10GY	095-954/10RD	095-955/10WH	095-956/10YL
14 FT	095-957/14BK	095-958/14BL	095-959/14GR	095-960/14GY	095-963/14RD	095-964/14WH	095-965/14YL
25 FT	095-975/25BK	095-976/25BL	095-977/25GR	095-978/25GY	095-981/25RD	095-982/25WH	095-983/25YL



#### Features:

- o CAT6 transmission performance
- o CM-Rated
- o Flame-retardant PVC jacket
- o Gold-plated contactss
- o RoHS-Compliant
- o 4 pairs of 24-AWG stranded insulated bare copper conductors

### CAT6 Patch Cords - UTP with Boot and Protector



Size	Black	Blue	Green	Gray	Orange	Purple	Red	White	Yellow
1/2 FT	094-786/05BK	094-787/05BL	094-788/05GR	094-789/05GY	094-790/05OR	094-791/05PR	094-792/05RD	094-793/05WH	094-794/05YL
1 FT	094-795/1BK	094-796/1BL	094-797/1GR	094-798/1GY	094-799/1OR	094-800/1PR	094-801/1RD	094-802/1WH	094-803/1YL
2 FT	094-804/2BK	094-805/2BL	094-806/2GR	094-807/2GY	094-808/2OR	094-809/2PR	094-810/2RD	094-811/2WH	094-812/2YL
3 FT	094-813/3BK	094-814/3BL	094-815/3GR	094-816/3GY	094-817/3OR	094-818/3PR	094-819/3RD	094-820/3WH	094-821/3YL
4 FT	094-821/4BK	094-8212/4BL	094-8213/4GR	094-8214/4GY	Special Order	Special Order	094-8217/4RD	094-8218/4WH	094-8219/4YL
5 FT	094-822/5BK	094-823/5BL	094-824/5GR	094-825/5GY	094-826/5OR	094-827/5PR	094-828/5RD	094-829/5WH	094-830/5YL
6 FT	094-8301/6BK	094-8302/6BL	094-8303/6GR	094-8304/6GY	094-8305/6OR	094-8306/6PR	094-8307/6RD	094-8308/6WH	094-8309/6YL
7 FT	094-831/7BK	094-832/7BL	094-833/7GR	094-834/7GY	094-835/7OR	094-836/7PR	094-837/7RD	094-838/7WH	094-839/7YL
10 FT	094-840/10BK	094-841/10BL	094-842/10GR	094-843/10GY	094-844/10OR	094-845/10PR	094-846/10RD	094-847/10WH	094-848/10YL
14 FT	094-849/14BK	094-850/14BL	094-851/14GR	094-852/14GY	094-853/14OR	094-854/14PR	094-855/14RD	094-856/14WH	094-857/14YL
20 FT	094-858/20BK	094-859/20BL	094-860/20GR	094-861/20GY	094-862/20OR	094-863/20PR	094-864/20RD	094-865/20WH	094-866/20YL
25 FT	094-867/25BK	094-868/25BL	094-869/25GR	094-870/25GY	094-871/25OR	094-872/25PR	094-873/25RD	094-874/25WH	094-875/25YL
35 FT	Special Order	094-8752/35BL	Special Order	094-8754/35GY	Special Order	Special Order	Special Order	094-8758/35WH	Special Order
50 FT	094-876/50BK	094-877/50BL	094-878/50GR	094-879/50GY	094-880/50OR	094-881/50PR	094-882/50RD	094-883/50WH	094-884/50YL
75 FT	094-885/75BK	094-886/75BL	094-887/75GR	094-888/75GY	094-889/75OR	094-890/75PR	094-891/75RD	094-892/75WH	094-893/75YL
100 FT	094-894/100BK	094-895/100BL	094-896/100GR	094-897/100GY	094-898/100OR	094-899/100PR	094-900/100RD	094-901/100WH	094-902/100YL



# Good news!

## Plenum-Rated Patch Cords are Available for Special Order



### CAT5E Patch Cords - UTP Non-Booted



#### Features:

- o CAT5E transmission performance
- o Flame-retardant PVC jacket
- o CM-Rated
- o Gold-Plated Contacts
- o RoHS-Compliant
- o 4 pairs of 24-AWG stranded insulated bare copper conductors

Size	Black	Blue	Green	Gray	Red	White	Yellow
1 FT	093-687/1BK	093-688/1BL	093-689/1GR	093-690/1GY	093-693/1RD	093-694/1WH	093-695/1YL
2 FT	093-696/2BK	093-697/2BL	093-698/2GR	093-699/2GY	093-702/2RD	093-703/2WH	093-704/2YL
3 FT	093-705/3BK	093-706/3BL	093-707/3GR	093-708/3GY	093-711/3RD	093-712/3WH	093-713/3YL
5 FT	093-714/5BK	093-715/5BL	093-716/5GR	093-717/5GY	093-720/5RD	093-721/5WH	093-722/5YL
7 FT	093-723/7BK	093-724/7BL	093-725/7GR	093-726/7GY	093-729/7RD	093-730/7WH	093-731/7YL
10 FT	093-732/10BK	093-733/10BL	093-734/10GR	093-735/10GY	093-738/10RD	093-739/10WH	093-740/10YL
14 FT	093-741/14BK	093-742/14BL	093-743/14GR	093-744/14GY	093-747/14RD	093-748/14WH	093-749/14YL
25 FT	093-759/25BK	093-760/25BL	093-761/25GR	093-762/25GY	093-765/25RD	093-766/25WH	093-767/25YL

### CAT5E Patch Cords - UTP with Boot and Protector



Size	Black	Blue	Green	Gray	Orange	Purple	Red	White	Yellow
1/2 FT	092-570/05BK	092-571/05BL	092-572/05GR	092-573/05GY	092-574/05OR	092-575/05PR	092-576/05RD	092-577/05WH	092-578/05YL
1 FT	092-579/1BK	092-580/1BL	092-581/1GR	092-582/1GY	092-583/1OR	092-584/1PR	092-585/1RD	092-586/1WH	092-587/1YL
2 FT	092-588/2BK	092-589/2BL	092-590/2GR	092-591/2GY	092-592/2OR	092-593/2PR	092-594/2RD	092-595/2WH	092-596/2YL
3 FT	092-597/3BK	092-598/3BL	092-599/3GR	092-600/3GY	092-601/3OR	092-602/3PR	092-603/3RD	092-604/3WH	092-605/3YL
4 FT	092-6051/4BK	092-6052/4BL	092-6053/4GR	092-6054/4GY	Special Order	092-6056/4PR	092-6057/4RD	092-6058/4WH	092-6059/4YL
5 FT	092-606/5BK	092-607/5BL	092-608/5GR	092-609/5GY	092-610/5OR	092-611/5PR	092-612/5RD	092-613/5WH	092-614/5YL
6 FT	092-6141/6BK	092-6142/6BL	092-6143/6GR	092-6144/6GY	092-6145/6OR	092-6146/6PR	092-6147/6RD	092-6148/6WH	092-6149/6YL
7 FT	092-615/7BK	092-616/7BL	092-617/7GR	092-618/7GY	092-619/7OR	092-620/7PR	092-621/7RD	092-622/7WH	092-623/7YL
10 FT	092-624/10BK	092-625/10BL	092-626/10GR	092-627/10GY	092-628/10OR	092-629/10PR	092-630/10RD	092-631/10WH	092-632/10YL
14 FT	092-633/14BK	092-634/14BL	092-635/14GR	092-636/14GY	092-637/14OR	092-638/14PR	092-639/14RD	092-640/14WH	092-641/14YL
20 FT	092-642/20BK	092-643/20BL	092-644/20GR	092-645/20GY	092-646/20OR	092-647/20PR	092-648/20RD	092-649/20WH	092-650/20YL
25 FT	092-651/25BK	092-652/25BL	092-653/25GR	092-654/25GY	Special Order	092-656/25PR	092-657/25RD	092-658/25WH	092-659/25YL
35 FT	Special Order	092-6592/35BL	Special Order	092-6594/35GY	Special Order	Special Order	Special Order	092-6598/35WH	Special Order
50 FT	092-660/50BK	092-661/50BL	092-662/50GR	092-663/50GY	092-664/50OR	092-665/50PR	092-666/50RD	092-667/50WH	092-668/50YL
75 FT	092-669/75BK	092-670/75BL	092-671/75GR	092-672/75GY	092-673/75OR	092-674/75PR	092-675/75RD	092-676/75WH	092-677/75YL
100 FT	092-678/100BK	092-679/100BL	092-680/100GR	092-681/100GY	092-682/100OR	092-683/100PR	092-684/100RD	092-685/100WH	092-686/100YL

OPTICAL FIBER BULK CABLE

CABLE MANAGEMENT & RACKS

INDUSTRIAL & HARSH ENVIRONMENTS

# HDMI Cable & Accessories

## HDMI High Speed Digital Cables with Ethernet - CL3 (In-Wall)



### Features:

- High-speed HDMI cable with amplifier (100 feet)
- Gold-plated Type-A 19-pin connectors
- 18 Gbps bandwidth – up to 4K
- Supports high refresh rates up to 360 Hz
- Directional (Input/Output) design
- RoHS compliant
- CL3 in-wall rated

Item #	Description
242-030/3FT	HDMI 2.0 Ultra HD 4Kx2K 60 HZ, 3 ft
242-032/6 FT	HDMI 2.0 Ultra HD 4Kx2K 60 HZ, 6 ft
242-034/10FT	HDMI 2.0 Ultra HD 4Kx2K 60 HZ, 10 ft
242-037/15FT	HDMI 2.0 Ultra HD 4Kx2K 60 HZ, 15 ft
242-038/25FT	HDMI 2.0 Ultra HD 4Kx2K 60 HZ, 25 ft
242-040/30FT	HDMI 2.0 Ultra HD 4Kx2K 60 HZ, 30 ft
242-042/50FT	HDMI 2.0 Ultra HD 4Kx2K 60 HZ, 50 ft
242-043/75FT	HDMI 2.0 Ultra HD 4Kx2K 60 HZ, 75 ft (Directional)
242-044/100FT	HDMI 2.0 with Amplifier, Ultra HD 4Kx2K 60 HZ, 100 ft (Directional)

## F81 Wall Plates



028-WP/F81R11



028-WP/1XF81

## HDMI Coupler



245-KJC/FF/180

[Wall Plates](#)

[P59](#)



### Features:

- Standard single-gang wall plate for easy installation
- Compatible with F81 and keystone configurations
- Reliable signal transmission for TV and broadband
- Durable construction for long-term use

Item #	Description
028-WP/1XF81	TV Wall Plate with one F81 Connector, White
028-WP/F81R11	Wall Plate with F-81 + RJ11 or RJ14 Connectors, Standard Single-Gang, White
245-KJC/FF/180	HDMI Keystone Coupler F/F (Female to Female)

# Coax Connectors & Keystone Inserts

## Coax Connectors



Item #	Description
083-1041/CP/S	F-Type Male Connector, Compression Type for RG6, Standard Shielded, 100 per bag
083-1042/CP/Q	F-Type Male Connector, Compression Type, for RG6 Quad Shielded, 100 per bag
083-1042/Q	F-Type Male Connector, Twist-On Type, for RG6 Quad Shielded, 100 per bag
083-1043/CP/BNC	BNC Compression Type Connector for RG59, 100 per bag
083-1044/CPRG11	Compression Type Connector for RG11 Dual and Quad Shield, 50 per bag

### RG6 STANDARD SHIELD

083-1041/CP/S



### RG6 QUAD SHIELD

083-1042/CP/Q



### RG59

083-1043/CP/BNC



083-1042/Q



### RG11

083-1044/CPRG11



## Strong connections. Clear signals.

Designed for RG59, RG6, and RG11 coax cables, F-type connectors provide a secure, low-loss connection for video, satellite, cable TV, and broadband applications. Available in compression, crimp, and twist-on styles for a perfect fit in any installation



## Keystone Inserts

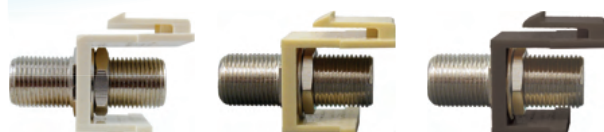

037-317AL

037-318IV

037-320BK

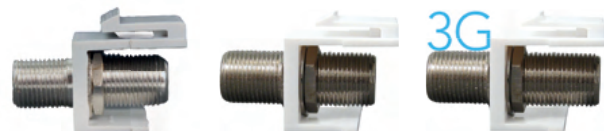

037-321GY

037-319WH

037-319WH/3G



037-329GY

037-325AL

037-326IV

037-327WH

037-328BK

Item #	Description
037-317AL	F Keystone Insert, Nickel Plated, Almond
037-318IV	F Keystone Insert, Nickel Plated, Ivory
037-319WH	F Keystone Insert, Nickel Plated, White
037-319WH/3G	F-81 Keystone Insert, Nickel Plated, 3.0 GHz Rated, Blue Insulator, White
037-320BK	F Keystone Insert, Nickel Plated, Black
037-321GY	F Keystone Insert, Nickel Plated, Gray
037-325AL	Blank Keystone Insert, Almond
037-326IV	Blank Keystone Insert, Ivory
037-327WH	Blank Keystone Insert, White
037-328BK	Blank Keystone Insert, Black
037-329GY	Blank Keystone Insert, Gray

[Blank Patch Panels](#)

P66

# Modular Plugs

COPPER BULK CABLE

## FEED-THROUGH

### CAT6A



012-025/EZF-100



012-026/EZF-100

### CAT6



012-023/EZF-100

### CAT5E



011-018/EZF-100



011-019/EZF-100

OPTICAL FIBER BULK CABLE

## NON FEED-THROUGH

### CAT6A



012-027SLM-100



012-021-100

### CAT6



012-022-100



### CAT5E



011-020G-100

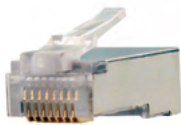

011-017-100



011-016-100

### CAT3



009-007/64R-100



009-008/66R-100



009-1024/44R

CABLE MANAGEMENT & RACKS

INDUSTRIAL & HARSH ENVIRONMENTS

Item #	Description
012-027SLM-100	CAT6A Slim Non-Feed-Through RJ45 Modular Plug, 3-Prong — Designed for 173 Series Cable, 100 per bag
012-026/EZF-100	CAT6A Feed-Through RJ45 Modular Plug, Shielded, 100 per bag
012-025/EZF-100	CAT6A Feed-Through RJ45 Modular Plug, Unshielded, 100 per bag
012-023/EZF-100	CAT6 Feed-Through RJ45 Modular Plug — For Solid and Stranded Cable, 100 per bag
012-022-100	CAT6 Non-Feed-Through RJ45 Modular Plug, 100 per bag
012-021-100	CAT6/CAT6A Shielded RJ45 Modular Plug — For Solid Cable, Includes Load Bar, 100 per bag
011-020G-100	CAT5E Shielded RJ45 Modular Plug with Grounding Hook — For Drain Wire, 100 per bag
011-019/EZF-100	CAT5E Feed-Through RJ45 Shielded Modular Plug — For Solid and Stranded Cable, 100 per bag
011-018/EZF-100	CAT5E Feed-Through RJ45 Modular Plug — For Solid and Stranded Cable, 100 per bag
011-017-100	CAT5E Shielded Plug, RJ45, 8P/8C, 3 Prong, for Round Solid/Stranded Cable, 100 per bag
011-016-100	CAT5E Plug, RJ45, 8P/8C, 3 Prong, for Round Solid/Stranded Cable, 100 per bag
009-1024/44R-100	CAT3 Plug, RJ22 Modular Plug   For telephone handset cord, 100 per bag
009-008/66R-100	CAT3 RJ12 Modular Plug (6C) — For Round Solid and Stranded Telephone Cable, 100 per bag
009-007/64R-100	CAT3 RJ11 Modular Plug (4C) — For Round Solid and Stranded Telephone Cable, 100 per bag

# Slip-On Boots

## RJ45 Slip-on Boots CAT6A, CAT6



016-047GR-50    016-045BK-50    016-046BL-50    016-048GY-50    016-051RD-50    016-052WH-50    016-053YL-50

### Features:

- 10 mm PVC slip-on-boot
- Fits CAT6 F/UTP, CAT6A UTP, CAT6A F/UTP cable
- Fits all Vertical Cable RJ45 plugs
- Provides strain relief and protects RJ45 plugs from snags



50-Pack

Item #	Description
016-045BK-50	Slip-On Boot, for CAT6/CAT6A, Black
016-046BL-50	Slip-On Boot, for CAT6/CAT6A, Blue
016-048GY-50	Slip-On Boot, for CAT6/CAT6A, Gray
016-047GR-50	Slip-On Boot, for CAT6/CAT6A, Green
016-051RD-50	Slip-On Boot, for CAT6/CAT6A, Red
016-052WH-50	Slip-On Boot, for CAT6/CAT6A, White
016-053YL-50	Slip-On Boot, for CAT6/CAT6A, Yellow

## RJ45 Slip-on Boots CAT6, CAT5E



015-031GR-10    015-027BK-10    015-029BL-10    015-033GY-10    015-035OR-10    015-037RD-10    015-039WH-10    015-041YL-10    015-045VT-10

### Features:

- 6.5 mm PVC slip-on-boot
- Fits CAT3 UTP, CAT5E UTP, CAT5E F/UTP, CAT6 UTP cable
- Fits all Vertical Cable RJ45 plugs except the 012-021-100 and 012-026-100 (CAT6A Shielded Plugs with the wing)
- Provides strain relief and prevents plugs from snagging



10-Pack

Item #	Description
015-027BK-10	Slip-On Boot, for CAT5E/CAT6, Black
015-029BL-10	Slip-On Boot, for CAT5E/CAT6, Blue
015-033GY-10	Slip-On Boot, for CAT5E/CAT6, Gray
015-031GR-10	Slip-On Boot, for CAT5E/CAT6, Green
015-035OR-10	Slip-On Boot, for CAT5E/CAT6, Orange
015-037RD-10	Slip-On Boot, for CAT5E/CAT6, Red
015-039WH-10	Slip-On Boot, for CAT5E/CAT6, White
015-041YL-10	Slip-On Boot, for CAT5E/CAT6, Yellow
015-045VT-10	Slip-On Boot, for CAT5E/CAT6, Violet

## Slip-on Boot for 012-027SLM-100

### Features:

- Compatible with RJ45 slim plugs (012-027SLM-100)
- Provides strain relief and protects RJ45 plugs from dust and snags
- 4 mm transparent PVC slip-on-boot
- 100 per bag



100-Pack



Item #	Description
017-067TR-100	CAT6A RJ45 Slip-on Boot for 012-027SLM-100 Plugs (Transparent)

# Tools & Testers

COPPER BULK CABLE

## Punch Down Tools

- Tools feature wide, comfortable handles
- Durable, long-lasting hardware



Item #	Description
078-2150	I-Punch Tool for Vertical Cable V-Max Keystone Jacks
078-2155/S	I-Punch Tool for Shielded Keystone Jacks
078-1025	Impact Punch Down Tool with 110/88/66 Blades
078-1025/B	110 Type Blade for 078-1025 Impact Punch Down Tool
078-1025/B210	Krone Type Blade for 078-1025 Impact Punch Down Tool

<a href="#">Keystone Jacks</a>	<a href="#">P54</a>	<a href="#">RJ45 Plugs</a>	<a href="#">P78</a>
--------------------------------	---------------------	----------------------------	---------------------



078-2150

078-2155/S

078-1025

078-1025/B210

078-1025/B

OPTICAL FIBER BULK CABLE

## Crimping & Compression Tools

- Tools feature wide, comfortable handles
- Durable, long-lasting hardware



Item #	Description
078-1017	Crimping Tool for RJ11, RJ12, RJ45, Built-in Cutting-Stripping Blade
078-2154/EZC/S	Tool for CAT6A Easy Feed RJ45 Modular Plug for Shielded Cable
078-2152/EZC	Crimping Tool for Feed-through Plugs
078-2153/B	Replacement Blade for EZ Feed Crimping Tool
078-1018	Compression Tool, Terminates RCA, BNC, RG59, RG6



078-1017

078-2154/EZC/S

078-2152/EZC

078-2153/B

078-1018

CABLE MANAGEMENT & RACKS

## Cutters & Strippers



Item #	Description
078-1023	Miniature 5 Adjustable Stripper/Cutter/Punch Down Tool, 10-30 AWG Wire, UTP/STP Round Cable
078-1024	Cable Cutter, Cuts Wire up to 0.42/10.7mm
078-1256	Coaxial Stripper, Thumbwind-Style, Adjustable Blade, For RG59 & RG6



078-1023

078-1024

078-1256

INDUSTRIAL & HARSH ENVIRONMENTS

# I-PUNCH TOOL by



**10,000-CUT  
BLADE STRENGTH**

**BUILT-IN  
CABLE CUTTER**

**FAST & CLEAN  
TERMINATIONS**

**DESIGNED  
EXCLUSIVELY  
FOR VC V-MAX  
KEYSTONE JACKS**



**BEST TIME AT TERMINATE THAT JACK TOURNAMENT**  
**18**  
**seconds**  
to terminate a jack

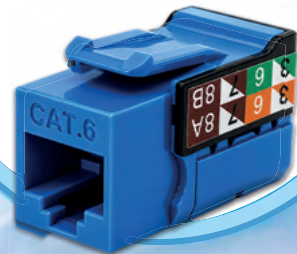

**DUAL RATCHETING  
MECHANISM**

**HEAVY-DUTY  
CONSTRUCTION**

**INTEGRATED  
HANDLE LOCK**



PART NUMBER  
**078-2150**

**IN STOCK  
AND READY TO  
SHIP**



**SHIPS FROM TEXAS  
CUT TO YOUR LENGTH  
NO CUT FEES**

# 2.

**OPTICAL FIBER**



## OPTICAL FIBER BULK CABLE - OSP

### Outside Plant Loose Tube

#### Non-Armored OS2 (Singlemode)

12-Fiber	281-NAR012/BK	
24-fiber	281-NAR024/BK	261-11902A
48-fiber	281-NAR048/BK	261-11906A
72-fiber	281-NAR072/BK	261-11908A
96-fiber	281-NAR096/BK	
144-fiber	281-NAR144/BK	261-11912A

#### Armored OS2 (Singlemode)

12-Fiber	282-ARM012/BK	
24-fiber	282-ARM024/BK	261-11918B
36-fiber	282-ARM036/BK	261-11920B
48-fiber	282-ARM048/BK	261-11922B
72-fiber	282-ARM072/BK	261-11924B
96-fiber	282-ARM096/BK	261-11926B
144-fiber	282-ARM144/BK	261-11928B

### SPECIAL ORDER

## LOOSE TUBE DROP CABLES - OSP

Loose tube fiber drop cable is the "last mile" in FTTH/FTTx deployments. These are tough, flexible, and built for aerial, duct, or direct burial installations

**277 - W1**

Fiber Type	Fiber Count	Cable Construction
<b>M1</b> OM1	<b>XXX</b>	<b>FDND</b> Flat Drop Non-Toneable Dry
<b>M2</b> OM2	00# - ###	<b>FDNG</b> Flat Drop Non-Toneable Gel-Filled
<b>M3</b> OM3		<b>FDTD</b> Flat Drop Toneable Dry
<b>M4</b> OM4		<b>FDTG</b> Flat Drop Toneable Gel-Filled
<b>SM</b> OS2 G652D		<b>1JNA</b> Single Jacket/No Armor
<b>S1</b> G657.A1		<b>1J1A</b> Single Jacket/Single Armor
<b>S2</b> G657.B2		<b>2J1A</b> Dual Jacket/Single Armor
		<b>2J2A</b> Dual Jacket/Double Armor
		<b>3J2A</b> Triple Jacket/Double Armor
		<b>2JNA</b> Dual Jacket/Non Armored

The Vertical Cable part number table includes key attributes related to cable design and optical performance. Please note that not all configurations shown below are available. Refer to product-specific data sheets or consult your sales representative to confirm valid options

## Optical Fiber Cable

# Outside Plant Loose Tube Cables - Non-Armored

### Features:

- o All-dry (Gel-free)
- o Loose Tube
- o All-Dielectric
- o Non-Armored
- o Color-Coded Fibers
- o UV Resistant
- o Water Blocking

### Applications:

- o Outside Plant Installations
- o Duct
- o Aerial Lashed
- o Air Blown Fiber

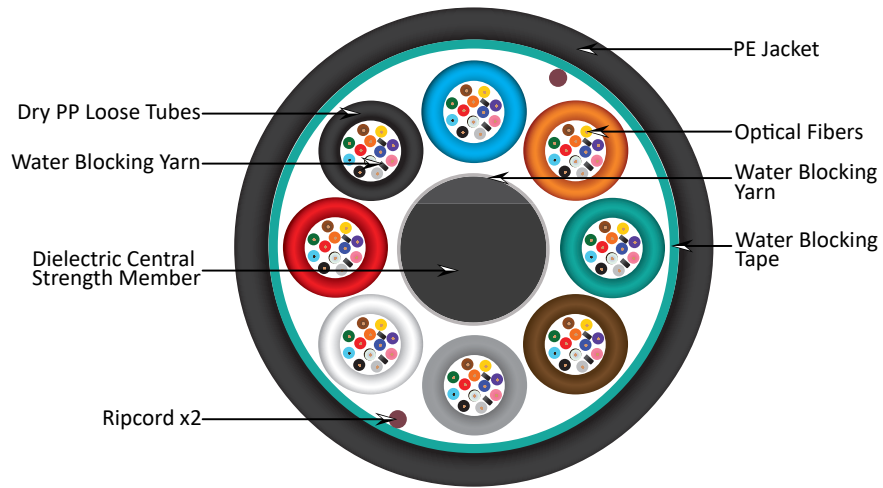

# Outside Plant Loose Tube Cables - Armored

### Features:

- o All-dry (Gel-free)
- o Flexible Loose Tube
- o Corrugated Steel Armor
- o Color-Coded Fibers
- o Water Blocking
- o UV Resistant
- o Crush Resistant
- o Impact Resistant
- o Aramid ripcords allow for easy stripping

### Applications:

- o Outside Plant Installations
- o Direct Burial
- o Duct
- o Aerial Lashed

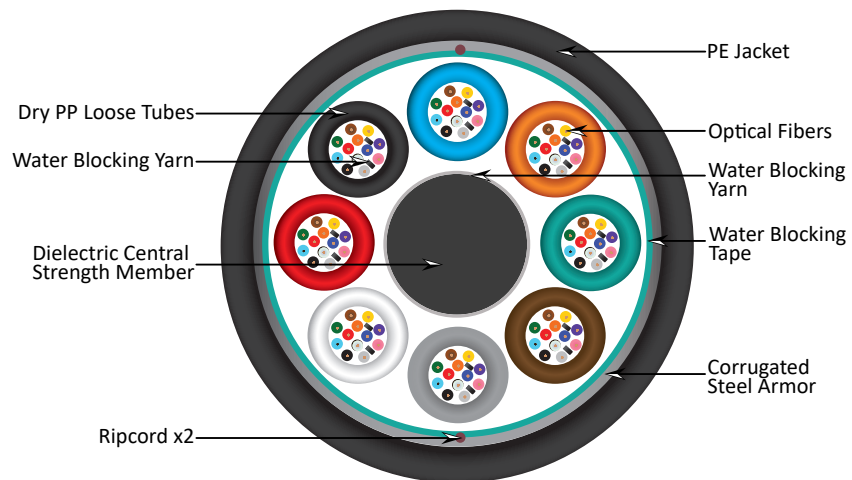

# OPTICAL FIBER BULK CABLE - ISP

## Indoor/Outdoor Tight Buffer (Distribution Cable) **Non-Armored**

<b>OM1 (Multimode)</b>	6-fiber 12-Fiber	271-1006/P/BK 271-1012/P/BK
<b>OM3 (Multimode)</b>	6-fiber 12-Fiber 24-fiber	273-3006/P/BK 273-3012/P/BK 273-3024/P/BK
<b>OM4 (Multimode)</b>	6-fiber 12-Fiber 24-fiber	274-4006/P/BK   261-13404P 274-4012/P/BK   261-13408P 274-4024/P/BK
<b>OS2 (Singlemode)</b>	6-fiber 12-Fiber 24-fiber	275-SM006/P/BK 275-SM012/P/BK 275-SM024/P/BK

## Indoor/Outdoor Tight Buffer (Distribution Cable) **Armored**

<b>OM3 (Multimode)</b>	6-fiber 12-Fiber 24-fiber	273-A5006/P/BK 273-A5012/P/BK 273-A5024/P/BK
<b>OM4 (Multimode)</b>	6-fiber 12-Fiber 24-fiber	274-A6006/P/BK 274-A6012/P/BK 274-A6024/P/BK
<b>OS2 (Singlemode)</b>	6-fiber 12-Fiber 24-fiber	275-ASM06/P/BK   275-ASM06/R/YL (Riser) 275-ASM12/P/BK 275-ASM24/P/BK

### SPECIAL ORDER

**ADSS (All-Dielectric Self-Supporting) cable** is available as a special order. Ask your account manager for more details

**2 7 6 - W 1**      -

Fiber Type	Fiber Count	Water Blocking	Span Length	NESC Loading	Construction
<b>M1</b> OM1	<b>XXX</b> OO# - ###	<b>G</b> Gel Filled	<b>S</b> Short Span > 300'	<b>L</b> Light	<b>S</b> Single Jacket
<b>M2</b> OM2		<b>T</b> Tape	<b>I</b> Intermediate 300' - 1000'	<b>M</b> Medium	<b>D</b> Double Jacket
<b>M3</b> OM3			<b>L</b> Long 1000' +	<b>H</b> Heavy	
<b>M4</b> OM4					
<b>SM</b> OS2 G652D					
<b>S1</b> G657.A1					
<b>S2</b> G657.B2					

The Vertical Cable part number table includes key attributes related to cable design and optical performance. Please note that not all configurations shown below are available. Refer to product-specific data sheets or consult your sales representative to confirm valid options

## Optical Fiber Cable

# Indoor/Outdoor Tight Buffer - Non-Armored - Plenum

### Features:

- o Tight buffered construction
- o Singlemode (OS2) or Multimode (OM1, OM3, OM4)
- o Color-coded for easy identification
- o OFNP Rated (Plenum Rated)
- o Rugged and high performance
- o Small size and light weight for limited conduit space
- o Suitable for lashed aerial, duct, underground conduit and indoor plenum applications
- o RoHS compliant

### Applications:

- o FTTx Networks
- o Indoor/Outdoor
- o Backbone & computer room cabling

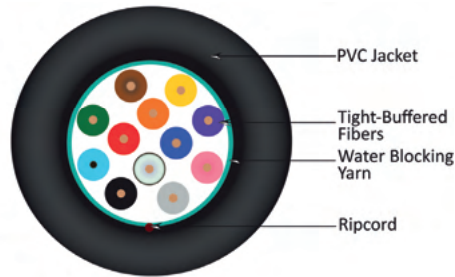

# Indoor/Outdoor Tight Buffer - Armored - Plenum

### Features:

- o Tight buffered construction
- o Singlemode (OS2) or Multimode (OM1, OM3, OM4)
- o Color-coded for easy identification
- o OFCP Rated
- o Rugged and high performance
- o Crush resistant
- o Small size and light weight for limited conduit space
- o Eliminates the need for inner duct or conduit thus saving installation time

### Applications:

- o FTTx deployments
- o Suitable for indoor or outdoor use
- o Backbone and computer room cabling
- o Local area networks (LAN)
- o High-security environments
- o Inter-building connections

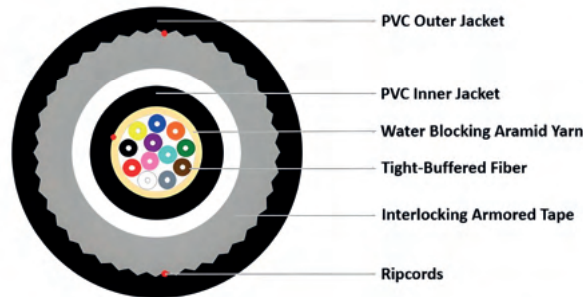

# Indoor Tight Buffer Cable - Armored - Riser

### Features:

- o Tight-buffered construction
- o OS2 singlemode performance
- o Aluminum interlocking armor for added protection
- o OFCR riser-rated for vertical installations
- o Crush-resistant, rugged design
- o Color-coded fibers for easy identification
- o Compact, lightweight for tight spaces
- o Eliminates need for inner duct or conduit
- o RoHS compliant, UL-Listed

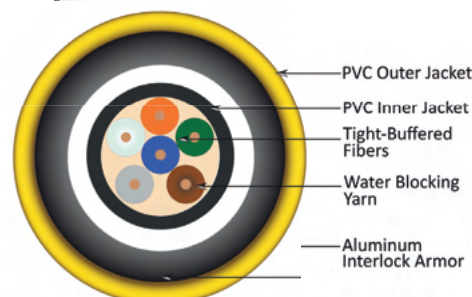



**VC**  
VERTICAL CABLE

09 1A-06 1A-09 1A-10 1A-11 1A-12

FIBER OPTIC PATCH PANEL	
1	2
3	4
5	6
7	8
9	10
11	12
13	14
15	16
17	18
19	20
21	22
23	24
25	26
27	28
29	30
31	32
33	34
35	36
37	38
39	40
41	42
43	44
45	46
47	48
49	50
51	52
53	54
55	56
57	58
59	60
61	62
63	64
65	66
67	68
69	70
71	72
73	74
75	76
77	78
79	80
81	82
83	84
85	86
87	88
89	90
91	92
93	94
95	96
97	98
99	100

# 2.1

**FIBER CONNECTIVITY**

# Work Area Surface-Mount Boxes

## Wall Outlets and Surface-Mount Boxes - Keystone Modules

**Black Bezels**

BLUE

GREEN

AQUA

HEATHER VIOLET



SC SX



264-KMB01-3Z-BK

264-KMB01-3Y-BK

264-KMB01-3C-BK

264-KMB01-3D-BK

LC DX



264-KMB01-4Z-BK

264-KMB01-4Y-BK

264-KMB01-4C-BK

264-KMB01-4D-BK

**Features:**

- Supports simplex and duplex fiber connections
- Precision zirconia ceramic sleeves for reliable alignment
- Fits standard keystone faceplates and surface-mount boxes
- Durable ABS housing (UL 94 V-0 rated)

**White Bezels**

BLUE

GREEN

AQUA

HEATHER VIOLET

SC SX



264-KMB01-3Z-WH

264-KMB01-3Y-WH

264-KMB01-3C-WH

264-KMB01-3D-WH

LC DX



264-KMB01-4Z-WH

264-KMB01-4Y-WH

264-KMB01-4C-WH

264-KMB01-4D-WH

## Keystone Modules - Shuttered

BLUE

GREEN

AQUA



SC SX



264-KMB03-3Z-WH

264-KMB03-3Y-WH

264-KMB03-3C-WH

LC DX

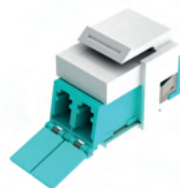

264-KMB03-4Z-WH

264-KMB03-4Y-WH

264-KMB03-4C-WH

**Features:**

- Simplex and duplex fiber compatibility
- Built-in shutter for dust protection and safety
- Zirconia ceramic sleeves for low insertion loss
- Compatible with standard keystone mounting systems
- UL 94 V-0 rated ABS construction

COPPER BULK CABLE

OPTICAL FIBER BULK CABLE

CABLE MANAGEMENT & RACKS

INDUSTRIAL & HARSH ENVIRONMENTS

# Fiber Done Right, Every Time.

## Related products:

Wall Plates **P59**



LGX Blank Keystone Adapter Plate **P100**

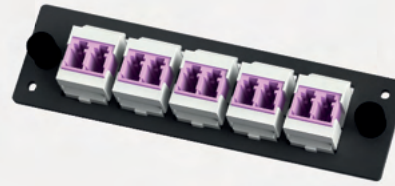

Surface mount boxes **P62**



Patch Panels **P68**

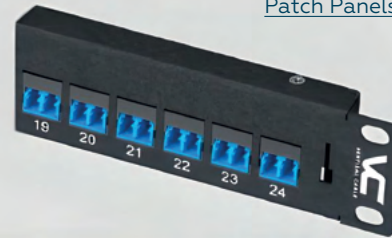

## Surface-Mount Box

Illustration of a loaded box with one adapter



Illustration of a box loaded with two adapters

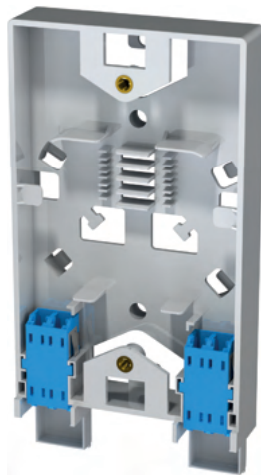

Blank (as delivered)



Zip ties and wood screws are included



Item #	Description
268-SMB12-2BW00	Work-Area Surface-Mount Box, 2-Position, Blank

### Features:

- Four slots for fusion splice protection sleeves
- Clear plastic label holder with adhesive mounting (included)
- W: 70 mm (2.75 in), H: 120 mm (4.7 in), D: 24 mm (1 in)
- Two wood screws (included)

Fiber adapters **P102**

# Rack-Mount Panels and Cable Management Bars

COPPER BULK CABLE

## LGX Adapter Plate Panels



266-PMD01-1A3A

Non-removable **cable manager**



266-PMD01-2A3A

**Cable Manager not included**  
Can take front and rear cable management bars

Item #	Description
266-PMD01-1A3A	Optical Fiber Rack-Mount Panel, LGX, Three-Position, 1 RMU
266-PMD01-2A3A	Optical Fiber Rack-Mount Panel, LGX, Three-Position, 1 RMU



OPTICAL FIBER BULK CABLE

**Label your rack!**  
**Use Zero-U panels to label your rack properly**



266-LBL00-A1A4A

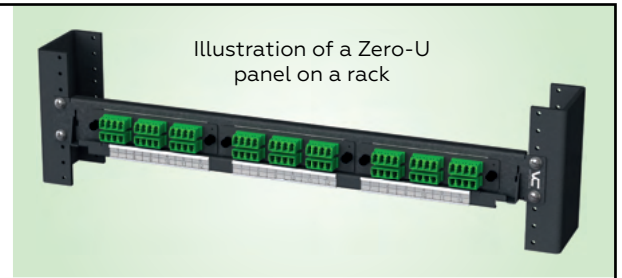

Illustration of a Zero-U panel on a rack

CABLE MANAGEMENT & RACKS

## Cable Management Bars



266-CFM00-2A3



266-CFM00-2A4

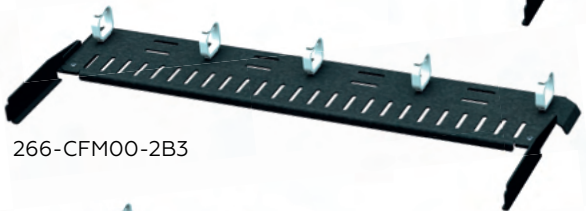

266-CFM00-2B3

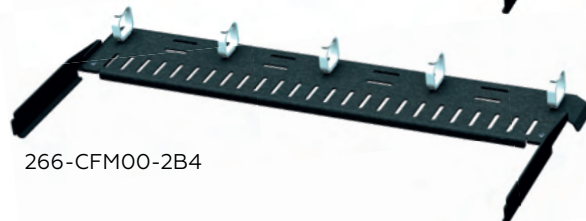

266-CFM00-2B4

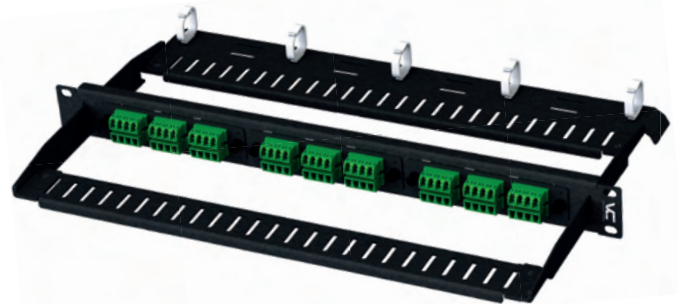

Illustration of LGX panel loaded with adapter plates and two cable management bars attached



Item #	Description
266-CFM00-2A3	Cable Management Bar, General Purpose, 3-in Depth
266-CFM00-2A4	Cable Management Bar, General Purpose, 4-in Depth
266-CFM00-2B3	Cable Management Bar, Optical Fiber, 3-in Depth
266-CFM00-2B4	Cable Management Bar, Optical Fiber, 4-in Depth



INDUSTRIAL & HARSH ENVIRONMENTS

# Rack-Mount Enclosures



## Rack-Mount Optical Fiber Enclosures - Standard Series

Illustration of Loaded Enclosures with LGX Adapter Plates			
<b>Number</b>	267-RES01-1C1	267-RES01-1F2	267-RES01-1L4
<b>Adapter plates (P87)</b>	3	6	12
<b>Optical fibers</b>	up to 72	up to 144	up to 288
<b>Splice trays (P98)</b>	2 x 24 fibers	6 x 24 fibers	12 x 24 fibers

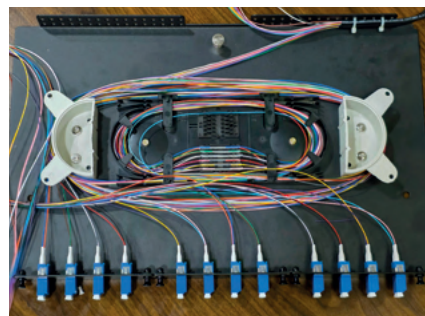
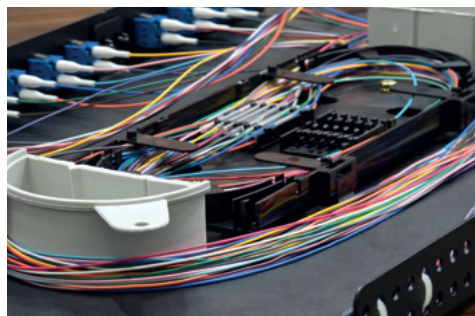
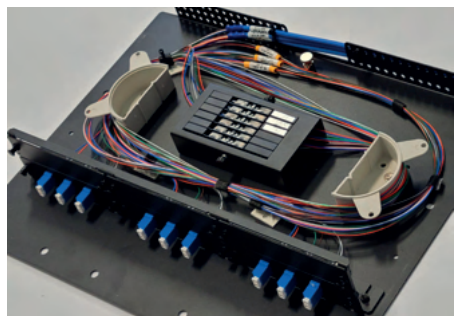
Item #	Description
267-RES01-1C1	Optical Fiber Rack-Mount Enclosure, Standard-Series, LGX, Three-Position, 1 RMU
267-RES01-1F2	Optical Fiber Rack-Mount Enclosure, Standard-Series, LGX, Six-Position, 2 RMU
267-RES01-1L4	Optical Fiber Rack-Mount Enclosure, Standard-Series, LGX, Twelve-Position, 4 RMU

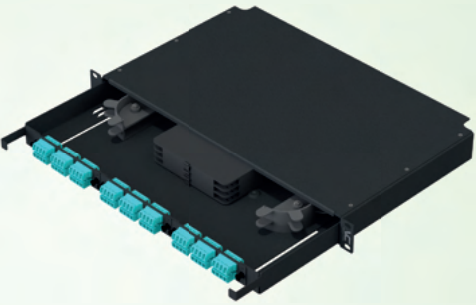

## Rack-Mount Optical Fiber Enclosures - Budget Series

Illustration of a loaded enclosure with LGX adapter plates and splicing trays		
		with cover
		
		with cover removed
<b>Number</b>	267-REB01-1C1	
<b>Adapter plates</b>	3	
<b>Optical fibers</b>	up to 72	
<b>Splice trays</b>	2 x 24 fibers	

Item #	Description
267-REB01-1C1	Optical Fiber Rack-Mount Enclosure, Budget-Series, LGX, Three-Position, 1 RMU



COPPER BULK CABLE

OPTICAL FIBER BULK CABLE

CABLE MANAGEMENT & RACKS

INDUSTRIAL & HARSH ENVIRONMENTS

# Wall-Mount Enclosures

## Wall-Mount Optical Fiber Enclosures

COPPER BULK CABLE

OPTICAL FIBER BULK CABLE

Item #	Description
268-STD01-1B1	Optical Fiber Wall-Mount Enclosure, Standard-Series, Single-Door, LGX, <b>Two-Position</b> , Latch
268-STD01-1D1	Optical Fiber Wall-Mount Enclosure, Standard-Series, Single-Door, LGX, <b>Four-Position</b> , Latch



268-STD01-1B1



As delivered



Illustration of a box loaded with cassettes and LGX adapter plates up to 48 fibers



Included:



268-STD01-1D1



As delivered



Illustration of a box loaded with cassettes and LGX adapter plates up to 96 fibers

Item #	Description
268-STD02-1B12	Optical Fiber Wall-Mount Enclosure, Standard-Series, Dual-Door, LGX, <b>Two-Position</b> , Lock/Latch
268-STD02-1D12	Optical Fiber Wall-Mount Enclosure, Standard-Series, Dual-Door, LGX, <b>Four-Position</b> , Lock/Latch

CABLE MANAGEMENT & RACKS

INDUSTRIAL & HARSH ENVIRONMENTS



268-STD02-1B12



As delivered



Illustration of a box loaded with LGX adapter plates up to 48 fibers



Included:



268-STD02-1D12

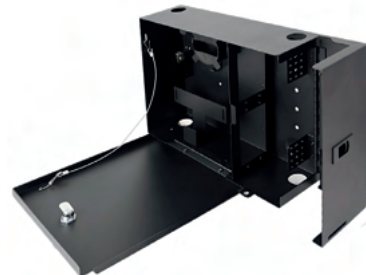

As delivered



Illustration of a box loaded with LGX adapter plates up to 96 fibers





# THE FIBER JOURNEY

FROM CENTRAL OFFICE  
TO EVERY CONNECTION

Reliable. Scalable. Future-Ready.

4

## DROP TO PREMISES / LAST MILE

Reliable connection that delivers high-speed service to end user.

3

## ACCESS POINTS / TAP SITES / PEDESTALS

Strategic access points for efficient splicing, distribution and network expansion.

2

## ROUTE DEPLOYMENT (UNDERGROUND / AERIAL / CONDUIT)

Secure and scalable routing solutions for long-distance fiber transport.

1

## CENTRAL OFFICE / BACKBONE START

High-capacity backbone infrastructure that powers the network.



WALL-MOUNT BOXES

LGX Adapter Plate Enclosures



Item #	Description
268-EZX01-1A1L1	EZX Series – Optical Fiber Wall-Mount Enclosure, LGX, Blank Door, Latch
268-EZV01-1A1L1	EZV Series – Optical Fiber Wall-Mount Enclosure, LGX, Viewport Door, Latch

268-EZX (Blank door)

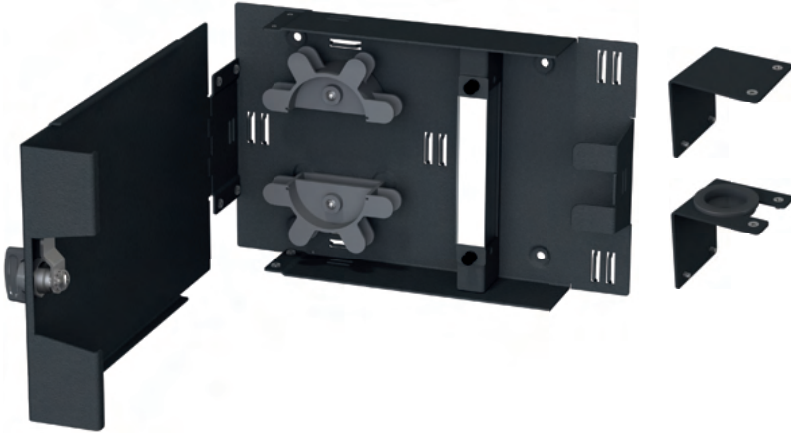

Features:

- LGX adapter plate format
- Single door, cam latch
- Left- or right-hand independent mounting
- Cable management: cable entry port adapters, cable anchor points (bridge lances), set of cable ties and wraps

268-EZV (Viewport door)

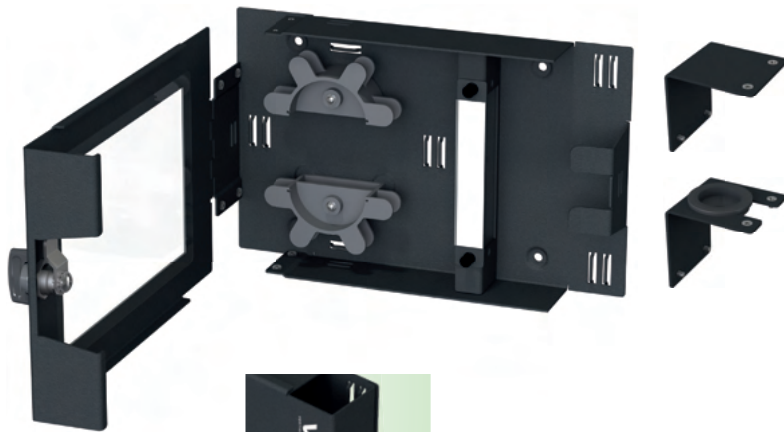

Latch



Example of a loaded box with LGX adapter plate (P69)

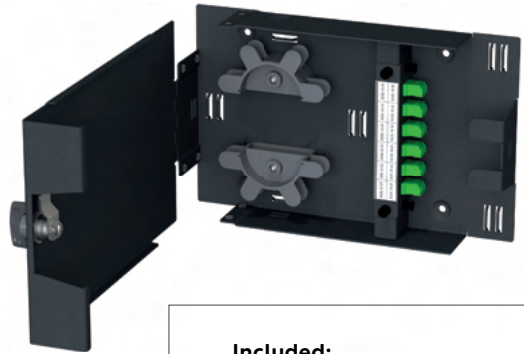

Included:

- Blank and Grommet cable entry adapters
- Label holder
- Cam latch
- Management spools



Example of a loaded box with LGX adapter plate (P69)

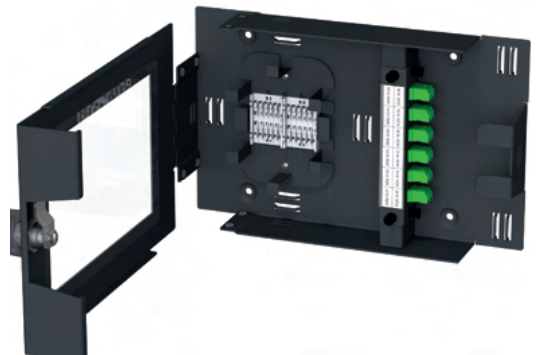

## ACCESSORIES – Cable entry adapters for EZX and EZV Series

“L” type



268-ACC01-1A0  
included with enclosure by default



“M” type



268-ACC01-2A0



268-ACC01-2B1



268-ACC01-2C1



268-ACC01-1B1  
included with enclosure by default



268-ACC01-1C1



268-ACC01-1D1



268-ACC01-2D1



268-ACC01-2E1



268-ACC01-2F2



268-ACC01-2G2



268-ACC01-1E1



268-ACC01-1F1



268-ACC01-1G1



268-ACC01-2H1



268-ACC01-2I1



268-ACC01-2J1

EZX and EZV enclosures are supplied with one blank and one grommet cable entry adapter brackets. Cable entry adapter brackets may be ordered separately, adding flexibility in creating configurations per project requirements:

## OTHER ACCESSORIES - EZX and EZV Series

Item #	Description
268-ACC03-11-00	Splicing Stage for 268-EZX/EZV Series
268-ACC03-12-00	Splicing Stage for 268-EZX/EZV Series, Two Splice Holders
265-HLD01-2B-00	Optical fiber splice holder, adhesive mounting, twelve fibers (no sleeves)
265-SLV01-3A-1H	Optical fiber splice protection sleeve, 2.5 mm x 40 mm, pack of 100
265-SLV01-3B-1H	Optical fiber splice protection sleeve, 2.5 mm x 60 mm, pack of 100
268-EZLOCK	Cam Lock for 268-EZX/EZV Series



Fiber Management Stage  
268-ACC03-11-00



Lock  
268-EZLOCK



40-mm sleeves  
265-SLV01-3A-1H



60-mm sleeves  
265-SLV01-3B-1H



Splice Holder  
265-HLD01-2B-00

# Adapter Plate Wall-Mount Box & Connectivity Node

COPPER BULK CABLE

## Adapter Plate Wall-Mount Box

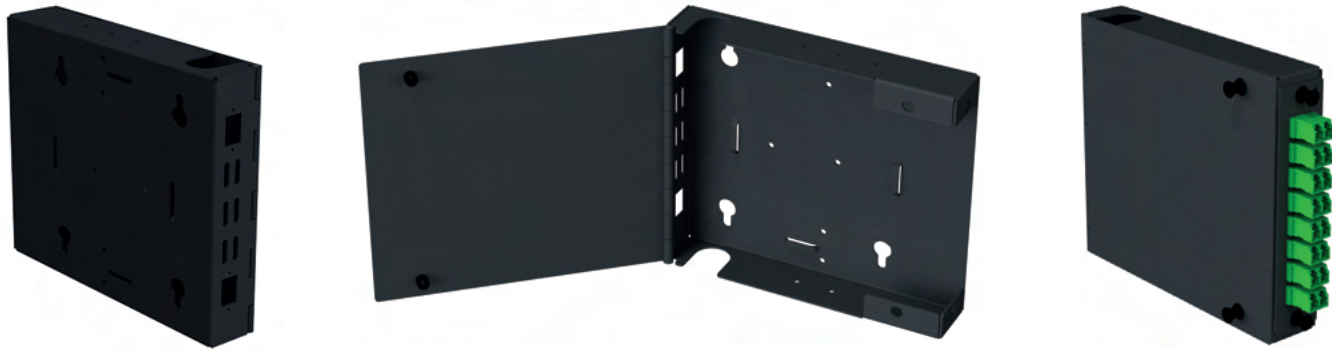

LGX Adapter plates are not included

### Features:

- One LGX adapter plate
- Up to 24 optical fibers
- Up to two 12-fiber splice holders
- W: 6.3 in, H: 1.6 in, D: 1.3 in
- 7 oz



### Item #

### Description

268-SMB01-1A1

Optical Fiber Surface-Mount Box, Standard-Series, LGX, One-Position

### Included:

Box with cover x 1; Panel fastener sets for cover latching x 2, nylon cable ties x 2

OPTICAL FIBER BULK CABLE

## Connectivity Node - Wall or DIN-Rail Mount Options

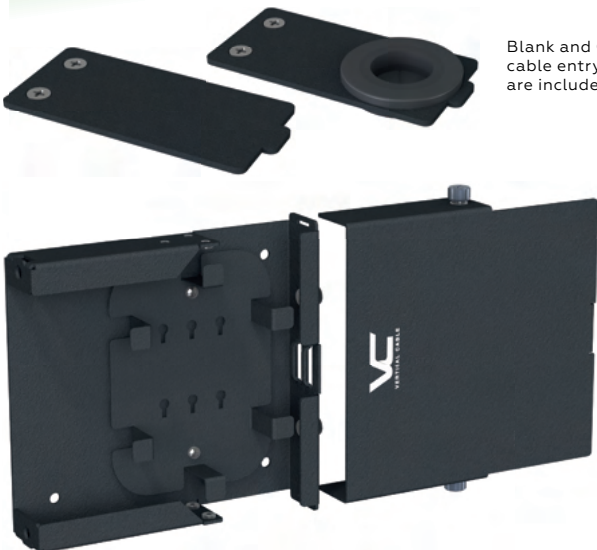

Blank and Grommet cable entry adapters are included

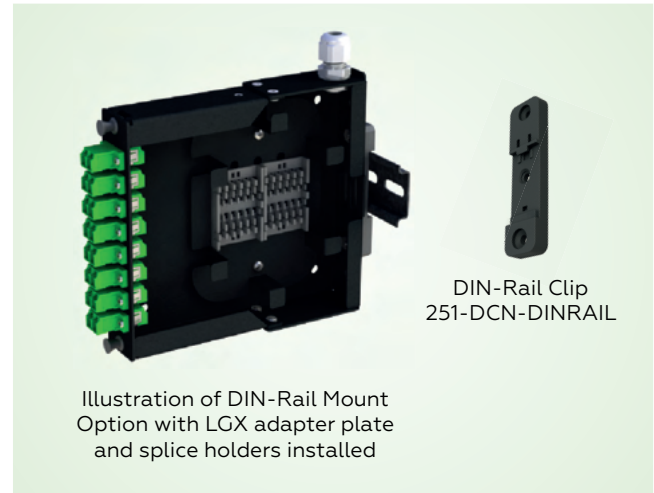

DIN-Rail Clip  
251-DCN-DINRAIL

Illustration of DIN-Rail Mount Option with LGX adapter plate and splice holders installed

### Features:

- One LGX adapter plate
- 1 or 2 splice holders, 12 fibers per holder, 24 fibers total max
- 1 or 2 cable entry point adapters (see accessories)
- Cable management: cable anchor points (bridge lances), fiber/splice management stage, removable, set of cable ties
- W: 1.2 in [2 DU], H: 5.9 in, D: 5.5 in
- 8.5 oz



### Item #

### Description

251-DCN01-B1B05

Wall-Mount Connectivity Node

### Included:

Base x 1; Cover x 1; FM stage x 1; Cable Tie x 2, Blank and Grommet cable entry adapters

CABLE MANAGEMENT & RACKS

INDUSTRIAL & HARSH ENVIRONMENTS

# DIN-Rail Modular Cassettes

## EZ Mount Series DIN-Rail Cassette



Blank and Grommet cable entry adapters are included

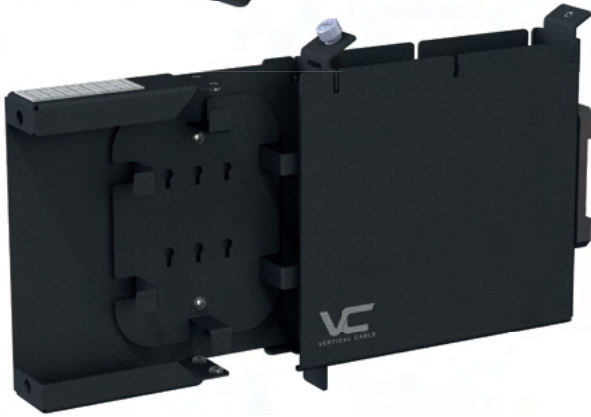

LGX Adapter plates are not included

[LGX Adapter plates](#) P100



### Features:

- One LGX adapter plate
- DIN-rail mounting only
- 1 or 2 splice holders, 12 fibers per holder, 24 fibers total
- Cable management: cable anchor points (bridge lances), fiber/splice management stage, removable, set of cable ties and wraps
- W: 1.4 in [2 DU], H: 6.7 in, D: 6 in
- 12.5 oz

Item #	Description
268-EZM01-1A-05	DIN-Rail Modular Cassette, EZ Mount Series

### Included:

Bay × 1; Cassette × 1; FM stage × 1; DIN-Rail Clip × 1; Cable Tie × 2, Blank and Grommet cable entry adapters

## ACCESSORIES – Cable Entry Adapters

251-DCN01 and 268-EZM Series use the same cable entry adapters

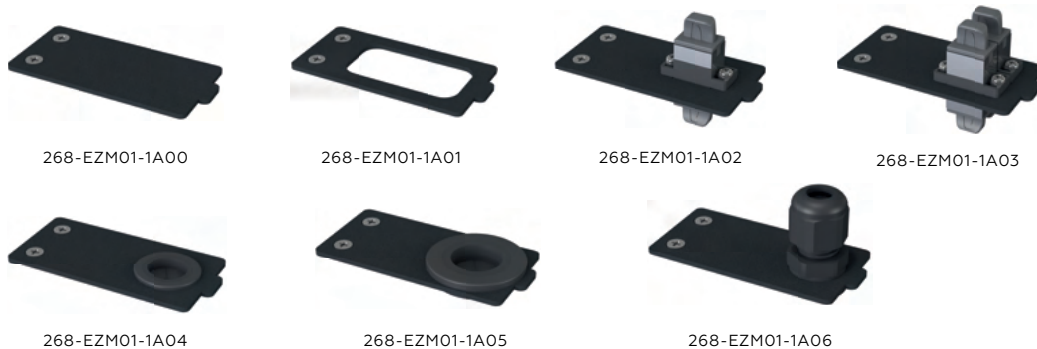

\* 268-EZM01-1A05 due to its grommet size can be used only in the top position



Splice holder  
265-HLD02-2B



Sleeves, 40 mm  
265-SLV01-3A-1H



Sleeves, 60 mm  
265-SLV01-3B-1H



DIN-Rail Clip  
251-DCN-DINRAIL

# LGX Adapter Plates

COPPER BULK CABLE

OPTICAL FIBER BULK CABLE

CABLE MANAGEMENT & RACKS

INDUSTRIAL & HARSH ENVIRONMENTS

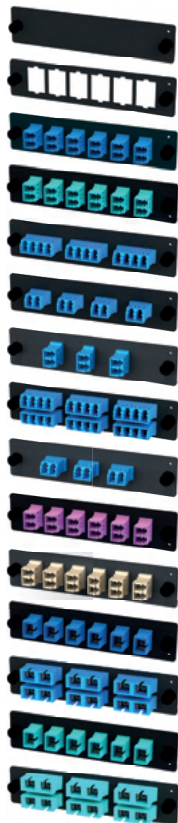

Item #	Description
264-MAPO0-0000	Optical Fiber Adapter Plate LGX Blank (Filler)
264-MAPO1-1A06	LGX Adapter Plate for Keystone inserts Blank
264-LAP04-1B6Z1	12F/6P LC/DX SM/UPC BL NF LGX
264-LAP04-1B6C1	12F/6P LC/DX MM/OM3 AQ NF LGX
264-LAP04-1C3Z1	12F/3P LC/QX SM/UPC BL NF LGX
264-LAP04-1B4Z1	8F/4P LC/DX SM/UPC BL NF LGX
264-LAP04-TB3Z1	6F/3P LC/DX SM/UPC BL NF VERT
264-LAP04-2C6Z1	24F/6P LC/QX SM/UPC BL NF LGX
264-LAP04-LB3Z1	6F/3P LC/DX SM/UPC BL NF HORZN
264-LAP04-1B6D1	12F/6P LC/DX MM/OM4 HV NF LGX
264-LAP04-1B6A1	12F/6P LC/DX MM/OM1 BG NF LGX
264-LAP03-1A8Z1	8F/8P SC/SX SM/UPC BL NF LGX
264-LAP03-2B6Z1	12F/6P SC/DX SM/UPC BL NF LGX
264-LAP03-1A8C1	8F/8P SC/SX MM/OM3 AQ NF LGX
264-LAP03-2B6C1	12F/6P SC/DX MM/OM3 AQ NF LGX

### Features:

- o LGX-compatible form factor for universal fit
- o Durable 1.5 mm aluminum construction with black powder coating
- o Available in singlemode and multimode configurations
- o Precision cutouts ensure secure adapter alignment
- o Meets Telcordia GR-326-CORE standards



## NEED SOMETHING ELSE? USE CONFIGURATOR:

**264-LAPO**  -

Connector	Position*	Footprint**	Number of Positions	Adapter Color	Adapter Mount***
<b>3</b> SC	<b>1</b> 1-Row	<b>A</b> SX	<b>1</b> 1-Position	<b>A</b> Beige	<b>1</b> NF (Flangeless)
<b>4</b> LC	<b>2</b> 2-Row	<b>B</b> DX	<b>2</b> 2-Position	<b>B</b> Black	<b>2</b> MF (Flanged)
	<b>T</b> Transversal	<b>C</b> QD	<b>3</b> 3-Position	<b>C</b> Aqua	
	<b>L</b> Lateral		<b>4</b> 4-Position	<b>D</b> Violet	
			<b>5</b> 6-Position	<b>Y</b> Green	
				<b>Z</b> Blue	

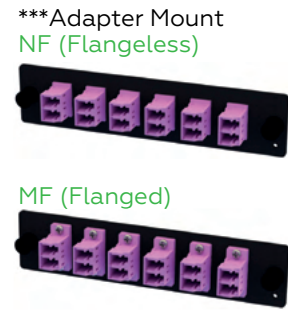
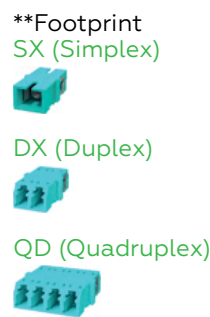
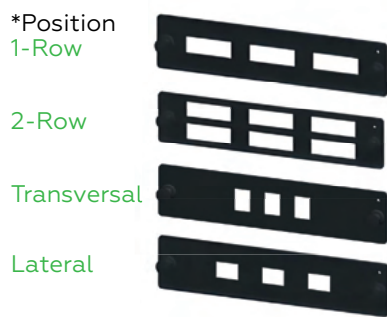

**Adapter Plates with Label ID CONFIGURATOR:**

**264-LAB0**  - **I**    **1**

Connector	Footprint**	Number of Positions	Adapter Color
<b>3</b> SC	<b>A</b> SX	<b>3</b> 3-Position	<b>A</b> Beige
<b>4</b> LC	<b>B</b> DX	<b>4</b> 4-Position	<b>B</b> Black
	<b>C</b> QD		<b>C</b> Aqua
			<b>D</b> Violet
			<b>Y</b> Green
			<b>Z</b> Blue

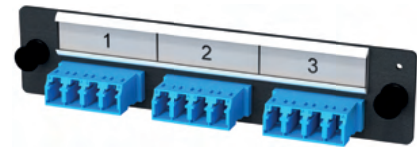

264-LAB04-IC3Z1

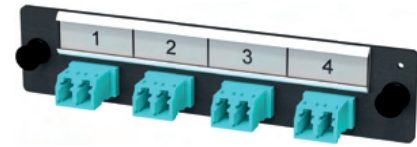

264-LAB04-IB4C1

**FC & ST Bulkhead Adapters CONFIGURATOR:**

**264-LAD0**  - **1A**   **01**

Connector	Number of Positions
<b>1</b> FC	<b>06</b> 6-Position
<b>2</b> ST	<b>08</b> 8-Position
	<b>12</b> 12-Position



264-LAD01-1A0801

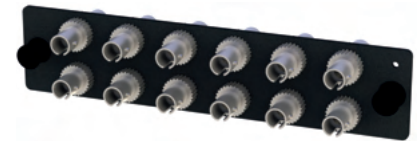

264-LAD02-1A1201

**MPO Adapter Plates CONFIGURATOR:**

**264-LAM05** - **1**

Orientation*	Number of Positions	Adapter Color	Adapter Mount
<b>M</b> KU-KD	<b>06</b> 6-Position	<b>B</b> Black	<b>1</b> NF (Flangeless)
<b>N</b> KU-KU	<b>08</b> 8-Position	<b>C</b> Aqua	<b>2</b> MF (Flanged)
<b>S</b> K-SW		<b>D</b> Violet	
		<b>Y</b> Green	
		<b>Z</b> Blue	



264-LAM5-1M06B2

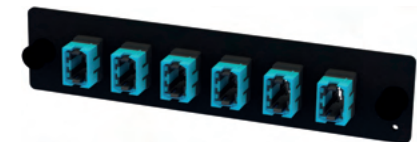

264-LAM05-1M06C1

\*Orientation  
 KU-KD = Key up - Key Down  
 KU-KU = Key up - Key Up  
 KU-SW = Key up - Switchable

# Optical Fiber Adapters

COPPER BULK CABLE

OPTICAL FIBER BULK CABLE

CABLE MANAGEMENT & RACKS

INDUSTRIAL & HARSH ENVIRONMENTS

## LC Adapters:

	Flangeless		Flanged	
	SX	QX	DX	QX
<b>OM1</b>	263-OFA04-2A1BG 	263-OFA04-3A1BG 	263-OFA04-2A2BG 	263-OFA04-3A2BG 
<b>OM3</b>	263-OFA04-2A1AQ 	263-OFA04-3A1AQ 	263-OFA04-2A2AQ 	263-OFA04-3A2AQ 
<b>OM4</b>	263-OFA04-2A1HV 	263-OFA04-3A1HV 	263-OFA04-2A2HV 	263-OFA04-3A2HV 
<b>SM UPC</b>	263-OFA04-2A1BL 	263-OFA04-3A1BL 	263-OFA04-2A2BL 	263-OFA04-3A2BL 
<b>SM APC</b>	263-OFA04-2A1GR 	263-OFA04-3A1GR 	263-OFA04-2A2GR 	263-OFA04-3A2GR 

### Connector Size

SX (Simplex)

DX (Duplex)

QD (Quadruplex)

### Flanged vs. Flangeless

When to use each:

Use Flanged when you want added mechanical strength—like in high-traffic racks, industrial settings, or where shake, rattle, and roll are real.

*Flanges with screw holes (screw mounting)*

Use Flangeless for a more streamlined install—great for modular data centers, clean environments, or any time you want faster installs and a sleeker look.

*Snap-in or retention within LGX panel*

### Features:

- Telcordia GR-326-CORE
- Split Zirconia ceramic sleeves
- Regulation (EC) No 1907/2006 (REACH); Directive 2011/65/EU (RoHS2). Plastic parts: ANSI/UL 94 V-0.

## SC Adapters:

	Flangeless		Flanged	
	SX	DX	SX	DX
<b>OM1</b>	263-OFA03-1A1BG 	263-OFA03-2A1BG 	263-OFA03-1A2BG 	263-OFA03-2A2BG 
<b>OM3</b>	263-OFA03-1A1AQ 	263-OFA03-2A1AQ 	263-OFA03-1A2AQ 	263-OFA03-2A2AQ 
<b>OM4</b>	263-OFA03-1A1HV 	263-OFA03-2A1HV 	263-OFA03-1A2HV 	263-OFA03-2A2HV 
<b>SM UPC</b>	263-OFA03-1A1BL 	263-OFA03-2A1BL 	263-OFA03-1A2BL 	263-OFA03-2A2BL 
<b>SM APC</b>	263-OFA03-1A1GR 	263-OFA03-2A1GR 	263-OFA03-1A2GR 	263-OFA03-2A2GR 

Color code reference (per ANSI/TIA-568.3):

- BEIGE: adapter is intended to be used for connecting cabling based on OM1 fiber
- AQUA: adapter is intended to be used for connecting cabling based on OM3 fiber
- VIOLET: adapter is intended to be used for connecting cabling based on OM4 fiber
- BLUE: adapter is intended to be used for connecting cabling based on SM fiber and UPC plugs
- GREEN: adapter is intended to be used for connecting cabling based on SM fiber and APC plugs



# KNOW YOUR OPTICAL FIBER ADAPTERS

## FC, ST, MPO, LC, SC

**FC Adapters:**

MM / SM

263-OFAFC-2RD



**ST Adapters:**

MM / SM

263-OFAST-2RD



**Multimode and Singlemode**

**MPO Adapters:**

Flangeless

263-OFA05-1B1BK



Flanged

263-OFA05-1B2BK



**OM3**

263-OFA05-1A1AQ



**SM UPC**

263-OFA05-1A1BL



**SM APC**

263-OFA05-1A1GR



**FC Optical Fiber Adapters**

Ferrule Connector (sometimes "Fixed Connector")

Main Use: Telecom, datacom, measurement equipment.

**ST Optical Fiber Adapters**

Straight Tip

Main Use: Networking, CCTV fiber, campus environments.

**MPO Optical Fiber Adapters**

Multi-Fiber Push-On

Main Use: High-density backbone cabling, data centers.

**SC Adapter**

Subscriber Connector (also "Square Connector" or "Standard Connector")

Main Use: Telecom room, GPON/ FTTH setups, CATV systems, General-purpose fiber connections.

**LC Adapters**

Lucent Connector (sometimes "Little Connector")

Main Use: Data centers, LAN/WAN connections, High-density fiber patching environments.

Dust-proof plugs (with integral key in Key-Switchable adapters).

**Products by Vertical Cable You Can Use Fiber Adapters with:**

[OSP Outlet Module Flangeless Adapters](#)

P145

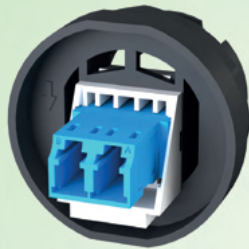

[OSP Transition Boxes Flanged Adapters](#)

P114

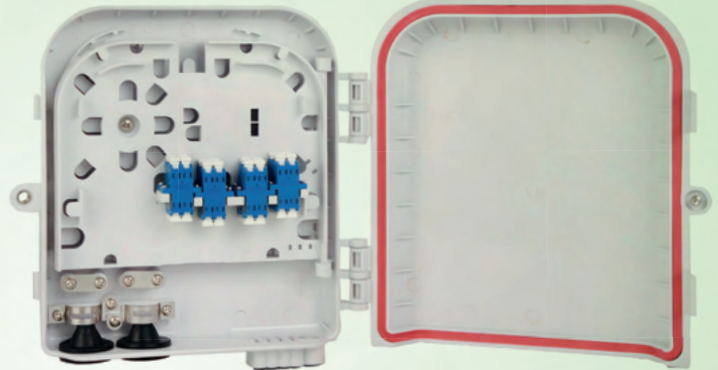

[Box loaded with two adapters Flangeless Adapters](#)

P91

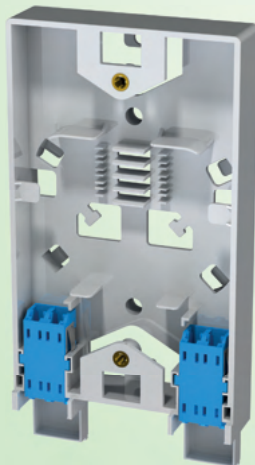

[LGX Adapter Plates Any adapters](#)

P67

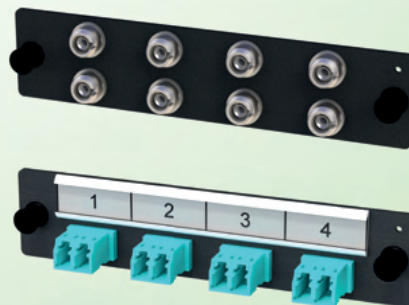

# Modular Connector Assemblies

## LGX Cassettes – MPO Pre-Connectorized Solution



264-MCA0312-3AAS1    264-MCA0412-3AAS1    264-MCA0U12-3AAS2    264-MCA0312-2AAS1    264-MCA0412-2AAS1    264-MCA0U12-2AAS2

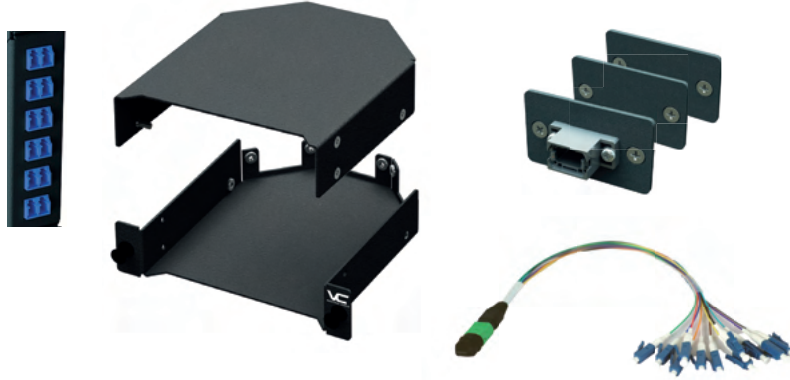

264-MCA0U12-3AAS2: Breakdown of what's inside of the cassette.  
**Comes fully pre-terminated and tested. Instant setup**

### Included:

- o 1 x base with cover;
- o 1 x front bracket with installed adapters;
- o 1 x wiring harness matching connector type and fiber count;
- o 1 x rear cable entry adapter plate with MPO adapter matching fiber type and count;
- o 2 x blank rear adapter plates.

### Features:

- o Mounting: Standard LGX footprint and mechanism
- o Low loss – MTP®-12 pinned (US Conec); Standard loss – MPO-12 pinned (SENKO)
- o W: 130 mm (5.12 in), H: 29 mm (1.14 in), D: 130 mm - 145 mm (5.12 in - 5.7 in)
- o Telcordia GR-326-CORE compatible

Item #	Description
264-MCA0312-3AAS1	MPO Pre-connectorized LGX cassette LC Multimode OM3, Standard Loss, Type-A, 1x MPO, 12-fiber
264-MCA0412-3AAS1	MPO Pre-connectorized LGX cassette LC Multimode OM4, Standard Loss, Type-A, 1x MPO, 12-fiber
264-MCA0U12-3AAS2	MPO Pre-connectorized LGX cassette LC Singlemode UPC, Standard Loss, Type-A, 1x MPO, 12-fiber
264-MCA0312-2AAS1	MPO Pre-connectorized LGX cassette SC Multimode OM3, Standard Loss, Type-A, 1x MPO, 12-fiber
264-MCA0412-2AAS1	MPO Pre-connectorized LGX cassette SC Multimode OM4, Standard Loss, Type-A, 1x MPO, 12-fiber
264-MCA0U12-2AAS2	MPO Pre-connectorized LGX cassette SC Singlemode UPC, Standard Loss, Type-A, 1x MPO, 12-fiber

## NEED SOMETHING ELSE? USE CONFIGURATOR:

2 6 4 - M C A 0    -  **A**

Fiber Type	Fiber Count	Connector	Polarity	Loss	MPO
<b>1</b> OM1	<b>08</b>	<b>2</b> SC	<b>A</b> A	<b>S</b> Standard Loss	<b>1</b> MPO1
<b>3</b> OM3	<b>12</b>	<b>3</b> LC	<b>B</b> B	<b>L</b> Low Loss	<b>2</b> MPO2
<b>4</b> OM4	<b>16</b>		<b>C</b> C		
<b>U</b> SM UPC	<b>24</b>				
<b>A</b> SM APC					

## LGX Cassettes – Splicing Cassettes



264-MCS0312-3A90    264-MCS0412-3A90    264-MCS0U12-3A90    264-MCS0312-2A90    264-MCS0412A90    264-MCS0U12-2A90

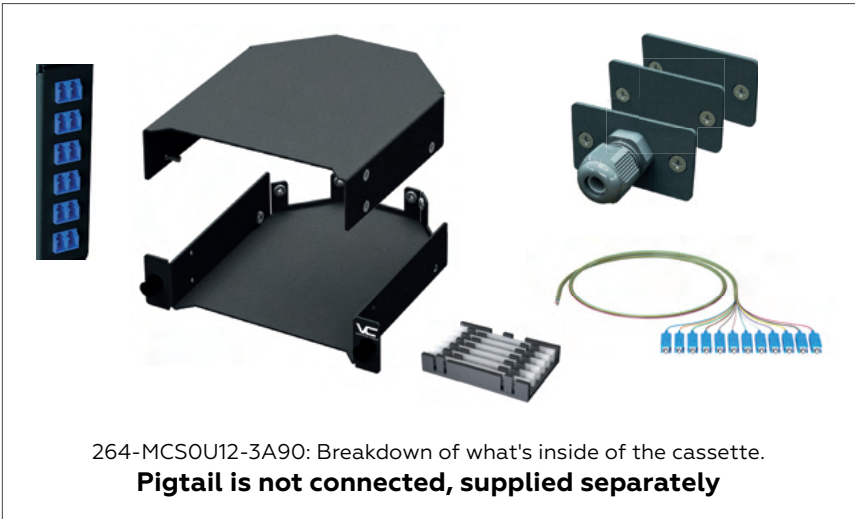

264-MCS0U12-3A90: Breakdown of what's inside of the cassette.  
**Pigtail is not connected, supplied separately**

- Included:**
- 1 × base with cover;
  - 1 × front bracket with installed adapters;
  - 1 × set of ANSI/TIA-598-color-coded pigtails matching connector type and fiber count;
  - 1 × set of splice holders matching fiber count with 265-SLV01-3A splice protection sleeves;
  - 1 × rear M12/PG7 cable gland adapter plate;
  - 2 × blank rear adapter plates.

- Features:**
- Mounting: Standard LGX footprint and mechanism
  - W: 130 mm (5.12 in), H: 29 mm (1.14 in), D: 130 mm - 145 mm (5.12 in - 5.7 in)
  - Telcordia GR-326-CORE compatible

Item #	Description
264-MCS0312-3A90	Splicing LGX cassette LC Multimode OM3, 900 μm matching pigtail, sleeves, splice holder, 12-fiber
264-MCS0412-3A90	Splicing LGX cassette LC Multimode OM4, 900 μm matching pigtail, sleeves, splice holder, 12-fiber
264-MCS0U12-3A90	Splicing LGX cassette LC Singlemode SM UPC, 900 μm matching pigtail, sleeves, splice holder, 12-fiber
264-MCS0312-2A90	Splicing LGX cassette SC Multimode OM3, 900 μm matching pigtail, sleeves, splice holder, 12-fiber
264-MCS0412A90	Splicing LGX cassette SC Multimode OM4, 900 μm matching pigtail, sleeves, splice holder, 12-fiber
264-MCS0U12-2A90	Splicing LGX cassette SC Singlemode SM UPC, 900 μm matching pigtail, sleeves, splice holder, 12-fiber

### NEED SOMETHING ELSE? USE CONFIGURATOR:

## 2 6 4 - M C S O     -   A 9 0

Fiber Type	Fiber Count	Connector
<b>1</b> OM1	<b>08</b>	<b>2</b> SC
<b>3</b> OM3	<b>12</b>	<b>3</b> LC
<b>4</b> OM4	<b>16</b>	
<b>U</b> SM UPC	<b>24</b>	
<b>A</b> SM APC		

# Mechanical Plugs

COPPER BULK CABLE

OPTICAL FIBER BULK CABLE

CABLE MANAGEMENT & RACKS

INDUSTRIAL & HARSH ENVIRONMENTS

## Mechanical - 12-Packs



### Features:

- o Factory pre-polished
- o Telcordia GR-326-CORE
- o Tools: Fiber stripper, fiber cleaver, cleaning wipes, VFL (optional)



Item #	Description
263-OSP03-10Z12	Singlemode UPC SC Plug, 2-3 mm buffered jacket, 12-pack
263-OSP03-10Y12	Singlemode APC SC Plug, 2-3 mm buffered jacket, 12-pack
263-OSP03-10A12	Multimode OM1 SC Plug, 2-3 mm buffered jacket, 12-pack
263-OSP03-10C12	Multimode OM3 SC Plug, 2-3 mm buffered jacket, 12-pack
263-OSP04-1FZ12	Singlemode UPC LC Plug, 2-3 mm buffered jacket, 12-pack
263-OSP04-1FY12	Singlemode APC LC Plug, 2-3 mm buffered jacket, 12-pack
263-OSP04-1BZ12	Singlemode UPC LC Plug, 0.9 mm tight buffered, 12-pack
263-OSP04-1BY12	Singlemode APC LC Plug, 0.9 mm tight buffered, 12-pack
263-OSP04-1BA12	Multimode OM1 LC Plug, 0.9 mm tight buffered, 12-pack
263-OSP04-1BC12	Multimode OM3 LC Plug, 0.9 mm tight buffered, 12-pack

[Cleaver](#) [P108](#)

[Tools](#) [P118](#)

### Singlemode UPC

263-OSP03-10Z12



### Singlemode APC

263-OSP03-10Y12



### Multimode OM1

263-OSP03-10A12



### Multimode OM3

263-OSP03-10C12



263-OSP04-1FZ12



263-OSP04-1FY12



263-OSP04-1BA12



263-OSP04-1BC12



263-OSP04-1BZ12



263-OSP04-1BY12

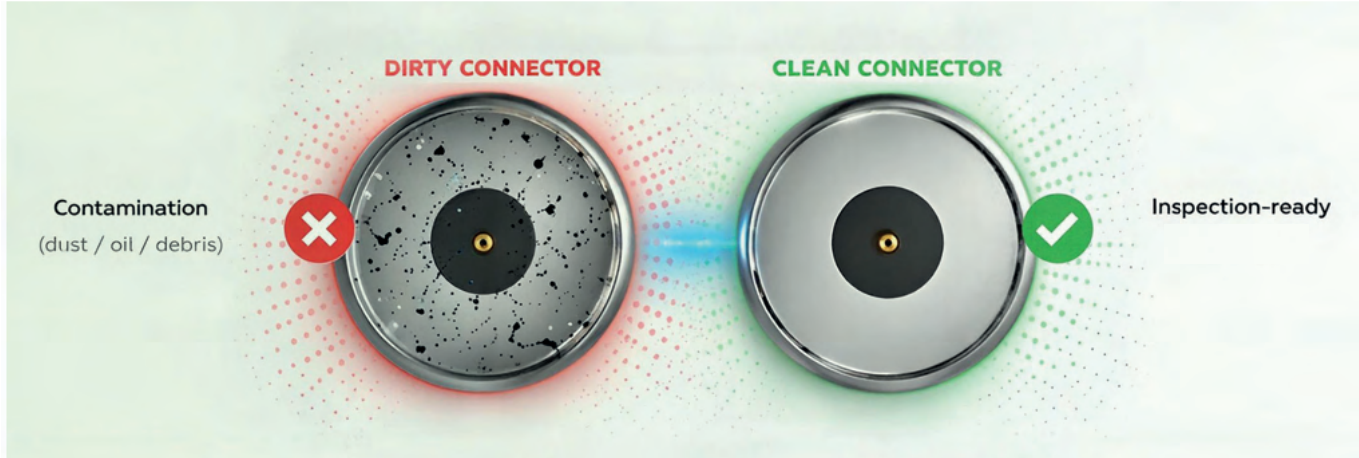

## Epoxy Plugs - 12-Packs



STD (Standard)



UNI (Unibody)

**Features:**

- Plugs of other colors are available as special orders, minimum order quantity – 100 plugs of each color
- Telcordia GR-326-CORE



[Cleaning Kit](#)

**P109**

Item #	Description
263-OFC01-1BY12	Singlemode APC FC Simplex Plug, 12-pack
263-OFC01-1BZ12	Singlemode UPC FC Simplex Plug, 12-pack
263-OFC03-1BY12	Singlemode APC SC Simplex Plug, 12-pack
263-OFC03-1BZ12	Singlemode UPC SC Simplex Plug, 12-pack
263-OFC03-1BC12	Multimode OM3 SC Simplex Plug, 12-pack
263-OFC04-1BY12	Singlemode APC LC Simplex Plug, 12-pack
263-OFC04-1BZ12	Singlemode UPC LC Simplex Plug, 12-pack
263-OFC04-2BY12	Singlemode APC LC Duplex Standard Plug, 12-pack
263-OFC04-2BZ12	Singlemode UPC LC Duplex Standard Plug, 12-pack
263-OFC04-2BC12	Multimode OM3 LC Duplex Standard Plug, 12-pack
263-OFC04-2BD12	Multimode OM4 LC Duplex Standard Plug, 12-pack
263-OFC04-3BY12	Singlemode APC LC Duplex Unibody Plug, 12-pack
263-OFC04-3BZ12	Singlemode UPC LC Duplex Unibody Plug, 12-pack
263-OFC04-3BC12	Multimode OM3 LC Duplex Unibody Plug, 12-pack
263-OFC04-3BD12	Multimode OM4 LC Duplex Unibody Plug, 12-pack

		SM UPC	SM APC	OM3	OM4
FC	SX	263-OFC01-1BZ12 	263-OFC01-1BY12 		
		263-OFC03-1BZ12 	263-OFC03-1BY12 	263-OFC03-1BC12 	
LC	SX	263-OFC04-1BZ12 	263-OFC04-1BY12 		
	DX	263-OFC04-2BZ12 	263-OFC04-2BY12 	263-OFC04-2BC12 	263-OFC04-2BD12 
		UNI	263-OFC04-3BZ12 	263-OFC04-3BY12 	263-OFC04-3BC12 

**Looks Clean.  
Isn't Clean.**

Even brand-new connectors can contain dust and contaminants that impact performance.

**Click. Clean. Connect.**

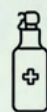

CLEANING KITS



CLEANING PENS



CLEANING WIPES

## Mechanical Splicing Tool Kit



Item #	Description
269-MSP01-01	Optical Fiber Mechanical Splicing Tool Kit

### Included:

No.	Item	Quantity	PN for reordering*
1	Cable cutter, round	1	078-1024
2	Cable jacket cutting and slitting tool, dia. 1.2 mm–6.4 mm	1	078-1022
3	Electrician's scissors	1	269-PAC04-0003
4	Optical fiber stripper, 3-step (2 mm–3 mm/0.9 mm/0.25 mm)	1	269-PAC05-0006
5	Kevlar shears, ceramic	1	269-PAC04-0005
6	Visual fault locator	1	269-PAC10-0001
7	Pre-moistened wipes, IPA, 1 pack	10	269-PAC03-0004
8	Cleaning agent dispensing bottle, 100 ml (3.4 fl oz)**	1	269-PAC03-0007
9	Permanent marker, fine-point, black	1	269-PAC05-0002
10	Ruler, SI/USCU, 6- or 12-in, stainless steel	1	269-PAC05-0003
11	Electrical tape, multicolor, six rolls, 18 mm x 2 m (0.7 in x 6.6 ft)	1	269-PAC05-0004
12	Storage container, five-compartment, 90 mm x 180 mm (3-½ in x 7 in), plastic, 2-pack	1	269-PAC02-0003
13	Safety goggles	1	269-PAC01-0001
14	Portable carrying soft-case bag	1	269-PAC02-0001

\*Re-ordered products may not be identical to those in the original kit but have the same functional properties. \*\*Spray bottle is supplied empty due to shipping safety restrictions



## Optical Fiber Cleavers and Replacement Blades



Item #	Description
269-CVR01-1A	Optical fiber precision cleaver with scrap collector
269-CVR01-1A-1	Replacement blade for 269-CVR01-1A
269-CVR02-1A	Optical fiber cleaver portable
269-CVR02-1A-1	Replacement blade for 269-CVR02-1A

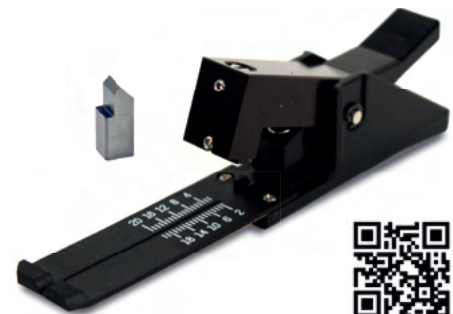

INSTALLATION, TESTING, MAINTENANCE

# Optical Fiber Cleaning Kit

Item #	Description
269-CLN01	Optical Fiber Cleaning Kit – Basic



**Included:**

No.	Item	Quantity	PN for reordering*
1	Optical fiber connector cleaner dispenser type	1	269-PAC03-0001
2	Cleaning foam swabs tipped 2.5-mm pack of 50	1	269-PAC03-0002
3	Cleaning foam swabs tipped 1.25-mm pack of 50	1	269-PAC03-0003
4	Pre-moistened wipes IPA 1-pack	10	269-PAC03-0004
5	Optical fiber connector cleaning cube 120 capacity	1	269-PAC03-0005
6	Cleaning agent dispensing bottle, 100 ml (3.4 fl oz)**	1	269-PAC03-0006

\*Re-ordered products may not be identical to those in the original kit but have the same functional properties.  
 \*\*Spray bottle is supplied empty due to shipping safety restrictions



INSTALLATION, TESTING, MAINTENANCE » Optical Fiber Tools

## Optical Fiber Cleaning Tools

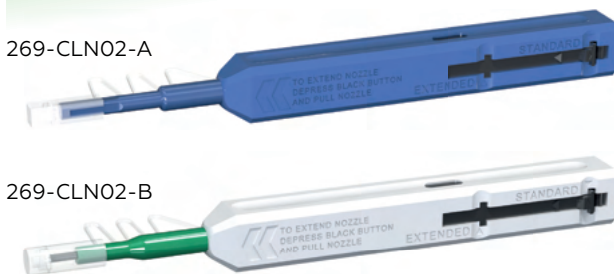

Item #	Description
269-CLN02-A	Optical Fiber Cleaning Pen Tool - 1.25-mm
269-CLN02-B	Optical Fiber Cleaning Pen Tool - 2.5-mm

**Click. Clean. Connect.**



# Splice Trays/Cassettes

COPPER BULK CABLE

OPTICAL FIBER BULK CABLE

CABLE MANAGEMENT & RACKS

INDUSTRIAL & HARSH ENVIRONMENTS

## Splice Trays/Cassettes



265-CAS01-1B200



265-CAS01-2B200

Item #	Description
265-CAS01-1B200	Optical fiber splice tray/cassette, <b>compact</b> , stackable, 24-fiber, black

265-CAS01-2B200	Optical fiber splice tray/cassette, <b>standard</b> , stackable, 24-fiber, <b>transparent cover</b> , black
-----------------	---

### Features:

- o Two splice holders
- o Fiber-management and slack storage mechanism
- o Cable anchoring points
- o Vertically stackable
- o Telcordia GR-771-CORE; RoHS-Compliant

[Fiber Enclosures](#) **P93**

## Array Splice Cassette

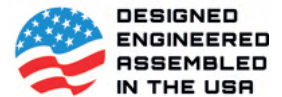

265-CAS10-F06A2

265-CAS10-F08A2

265-CAS10-F12A2



### Features:

- o Compatible splicing: fusion splice, heat-shrink protection sleeves
- o Cartridges: 6, 8 and 12
- o Sleeve size: 40 mm (1.6 in)
- o Mounting: 2 x M3x0.5x5 CTS machine screws
- o Telcordia GR-771-CORE; ANSI/UL 94 V-2; RoHS

Item #	Description
265-CAS10-F06A2	Array Splice Cassette, <b>6-Position</b> , up to 72 splices/fibers

265-CAS10-F08A2	Array Splice Cassette, <b>8-Position</b> , up to 96 splices/fibers
-----------------	--

265-CAS10-F12A2	Array Splice Cassette, <b>12-Position</b> , up to 144 splices/fibers
-----------------	--

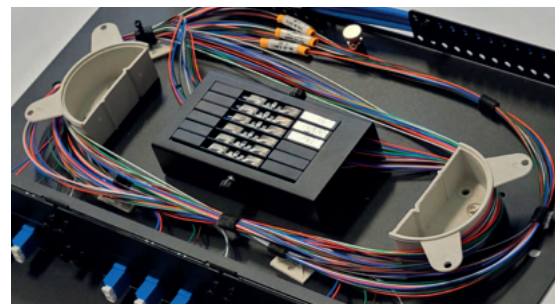
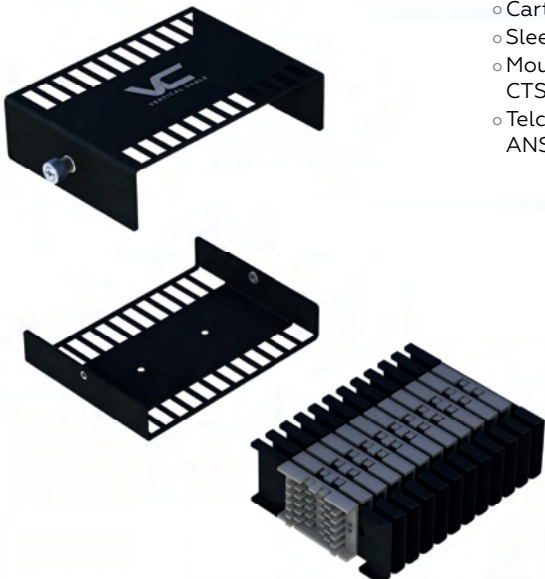

## Fusion Splice Holders

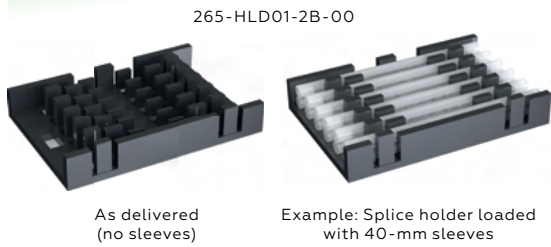

**Features:**

- Fusion splice, heat-shrink protection sleeves
- 6 slots × 2 fibers/slot = 12 fibers
- Adhesive pad (265-HLD01-2B-00), no pad (265-HLD02-2B#)

Item #	Description
265-HLD01-2B-00	Optical fiber splice holder, <b>adhesive mounting</b> , two fibers per slot, six slots, twelve fibers
265-HLD02-2B	Optical fiber splice holder, <b>mechanical mounting</b> , two fibers per slot, six slots, twelve fibers

## Fusion Splice Protection Sleeves



Item #	Description
265-SLV01-3A-1H	Optical fiber splice protection sleeve, 2.5 mm × <b>40 mm</b> , pack of 100
265-SLV01-3B-1H	Optical fiber splice protection sleeve, 2.5 mm × <b>60 mm</b> , pack of 100

## Mechanical Splices and Splice Holders



Item #	Description
265-MEC01-E	Optical fiber mechanical splice, <b>universal</b> , 0.25 and 0.9 mm, pack of six
265-HLD11-2B4-0	Optical fiber mechanical splice, <b>stackable</b> (two splices/slot), adhesive mounting, 12-fiber

**Features:**

- Mechanical splice
- Single fiber
- Fiber coating size: 250 µm–900 µm

## Fan-out Kits

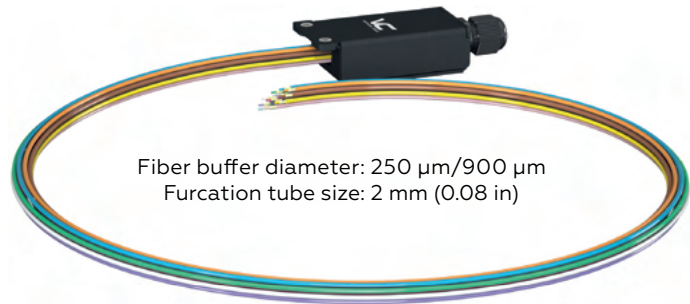
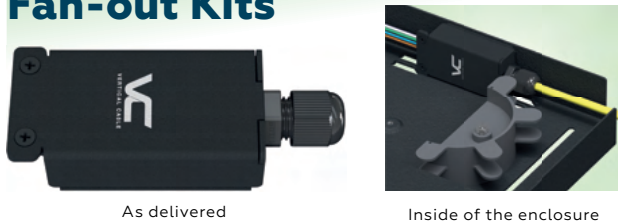

Fiber buffer diameter: 250 µm/900 µm  
Furcation tube size: 2 mm (0.08 in)



Item #	Description
269-FOK06-580C	Optical Fiber Cable Fan-out Kit, <b>6-Fiber</b> , Color tubes, 1-m (40-in) legs
269-FOK12-580C	Optical Fiber Cable Fan-out Kit, <b>12-Fiber</b> , Color tubes, 1-m (40-in) legs



# Optical Fiber Patch Cords

## Singlemode UPC Polish - CUSTOM LENGTHS AVAILABLE



Size	ST-ST	LC-ST	LC-SC	SC-SC	SC-ST	LC-LC
1 m	261-STST/1SM	261-LCST/1SM	261-LCSC/1SM	261-SCSC/1SM	261-SCST/1SM	261-LCLC/1SM
2 m	261-STST/2SM	261-LCST/2SM	261-LCSC/2SM	261-SCSC/2SM	261-SCST/2SM	261-LCLC/2SM
3 m	261-STST/3SM	261-LCST/3SM	261-LCSC/3SM	261-SCSC/3SM	261-SCST/3SM	261-LCLC/3SM
5 m	261-STST/5SM	261-LCST/5SM	261-LCSC/5SM	261-SCSC/5SM	261-SCST/5SM	261-LCLC/5SM
7 m	261-STST/7SM	261-LCST/7SM	261-LCSC/7SM	261-SCSC/7SM	261-SCST/7SM	261-LCLC/7SM
10 m	261-STST/10SM	261-LCST/10SM	261-LCSC/10SM	261-SCSC/10SM	261-SCST/10SM	261-LCLC/10SM
15 m	261-STST/15SM	261-LCST/15SM	261-LCSC/15SM	261-SCSC/15SM	261-SCST/15SM	261-LCLC/15SM

## Multimode OM1



Size	ST-ST	LC-ST	LC-SC	SC-SC	SC-ST	LC-LC
1 m	261-STST/1MM	261-LCST/1MM	261-LCSC/1MM	261-SCSC/1MM	261-SCST/1MM	261-LCLC/1MM
2 m	261-STST/2MM	261-LCST/2MM	261-LCSC/2MM	261-SCSC/2MM	261-SCST/2MM	261-LCLC/2MM
3 m	261-STST/3MM	261-LCST/3MM	261-LCSC/3MM	261-SCSC/3MM	261-SCST/3MM	261-LCLC/3MM
5 m	261-STST/5MM	261-LCST/5MM	261-LCSC/5MM	261-SCSC/5MM	261-SCST/5MM	261-LCLC/5MM
7 m	261-STST/7MM	261-LCST/7MM	261-LCSC/7MM	261-SCSC/7MM	261-SCST/7MM	261-LCLC/7MM
10 m	261-STST/10MM	261-LCST/10MM	261-LCSC/10MM	261-SCSC/10MM	261-SCST/10MM	261-LCLC/10MM
15 m	261-STST/15MM	261-LCST/15MM	261-LCSC/15MM	261-SCSC/15MM	261-SCST/15MM	261-LCLC/15MM

## Multimode OM3



Size	ST-ST	LC-ST	LC-SC	SC-SC	SC-ST	LC-LC
1 m	263-STST/1MM	263-LCST/1MM	263-LCSC/1MM	263-SCSC/1MM	263-SCST/1MM	263-LCLC/1MM
2 m	263-STST/2MM	263-LCST/2MM	263-LCSC/2MM	263-SCSC/2MM	263-SCST/2MM	263-LCLC/2MM
3 m	263-STST/3MM	263-LCST/3MM	263-LCSC/3MM	263-SCSC/3MM	263-SCST/3MM	263-LCLC/3MM
5 m	263-STST/5MM	263-LCST/5MM	263-LCSC/5MM	263-SCSC/5MM	263-SCST/5MM	263-LCLC/5MM
7 m	263-STST/7MM	263-LCST/7MM	263-LCSC/7MM	263-SCSC/7MM	263-SCST/7MM	263-LCLC/7MM
10 m	Call	Call	Call	263-SCSC/10MM	Call	263-LCLC/10MM
15 m	Call	Call	Call	263-SCSC/15MM	Call	263-LCLC/15MM

## Singlemode APC Polish

Size	SC-SC
1 m	261-ASC-ASC/1SM
2 m	261-ASC-ASC/2SM
3 m	261-ASC-ASC/3SM
5 m	261-ASC-ASC/5SM



## Multimode OM4

Size	LC-LC
1 m	264-LCLC/1MM
2 m	264-LCLC/2MM
3 m	264-LCLC/3MM



COPPER BULK CABLE

OPTICAL FIBER BULK CABLE

CABLE MANAGEMENT & RACKS

ONMENTS

IN

# OSP Transition Boxes

COPPER BULK CABLE

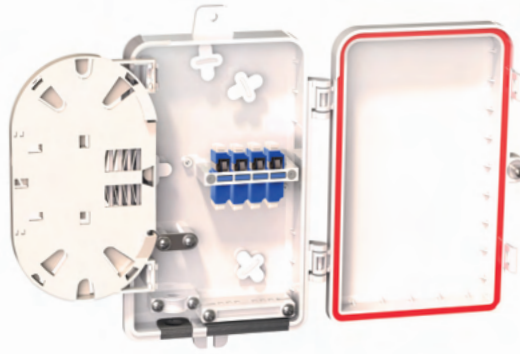

cable inlets: x1  
cable outlets: x6



Supplied without fiber adapters.  
**COMPATIBLE ONLY WITH  
FLANGED ADAPTERS.**

268-OPB01-104

[Fiber Adapters](#)

[P102](#)

OPTICAL FIBER BULK CABLE

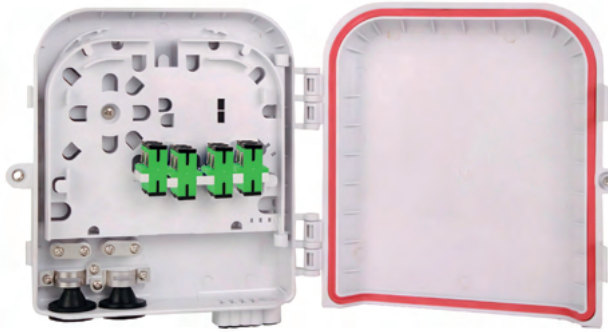

cable inlets: x2  
cable outlets: x8

268-OPB01-208

CABLE MANAGEMENT & RACKS

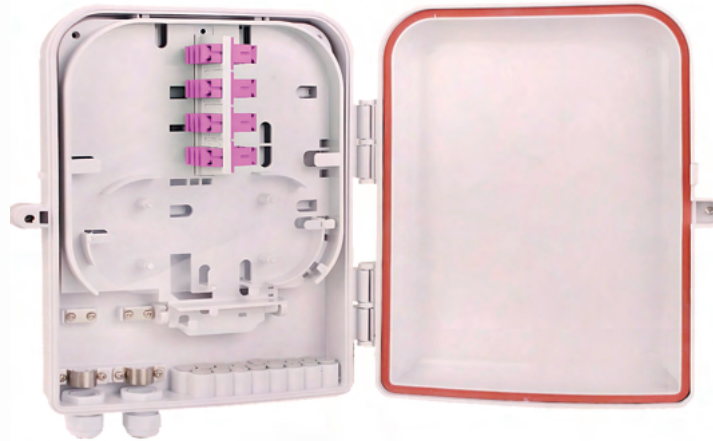

cable inlets: x2  
cable outlets: x16

268-OPB01-216

**Features:**

- o ANSI/TIA-568.3-D, GR-769
- o Operating temperature: -10 °C–60 °C (14 °F–140 °F)
- o High-impact, UV-resistant, water-resistant
- o Sealing rating: IP65

**Applications:**

- o Outdoor (FTTx, CATV, etc.)

**Item #**

**Description**

268-OPB01-104	Optical Fiber OSP Transition Box, 4 slots
268-OPB01-208	Optical Fiber OSP Transition Box, 8 slots
268-OPB01-216	Optical Fiber OSP Transition Box, 16 slots



INDUSTRIAL & HARSH ENVIRONMENTS

# OSP Splice Closures

## Horizontal, In-line



265-OSC00-09606



265-OSC00-09608



265-OSC00-24006

Item #	Description
265-OSC00-09606	OSP Splice Closure, Horizontal, In-line, 96-fiber capacity, 6 cable entry ports, up to 96 fibers, IP68, UV resistant
265-OSC00-09608	OSP Splice Closure, Horizontal, In-line, 96-fiber capacity, 8 cable entry ports, up to 96 fibers, IP68, UV resistant
265-OSC00-24006	OSP Splice Closure, Horizontal, In-line, 240-fiber capacity, 6 cable entry ports, up to 240 fibers, IP68, UV resistant



## Vertical, Dome



265-OSC10-04804



265-OSC10-09602



265-OSC10-28806

### Features:

- High-impact fiber-reinforced PC
- UV resistant
- IP68
- Operating temperature: -40 °C–65 °C (-40 °F–149 °F)

Item #	Description
265-OSC10-04804	OSP Splice Closure, Vertical, Dome, 48-fiber capacity, 4 cable entry ports, up to 48 fibers, IP68, UV resistant
265-OSC10-09602	OSP Splice Closure, Vertical, Dome, 96-fiber capacity, 2 cable entry ports, up to 96 fibers, IP68, UV resistant
265-OSC10-28806	OSP Splice Closure, Vertical, Dome, 288-fiber capacity, 6 cable entry ports, up to 288 fibers, IP68, UV resistant

# Installation Accessories

COPPER BULK CABLE

OPTICAL FIBER BULK CABLE

CABLE MANAGEMENT & RACKS

INDUSTRIAL & HARSH ENVIRONMENTS

## OSP Tension Clamps

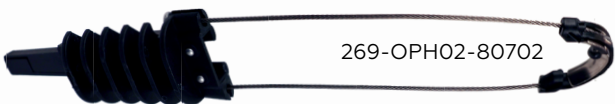

269-OPH02-80702



269-OPH02-D10P7



048-301/TC

Item #	Description
269-OPH02-80702	OSP Tension Clamps - Self-supporting drop 8 in, fiber-reinforced plastic (FRP) or aramid yarn messenger 3 mm–7 mm (0.12 in–0.3 in)
269-OPH02-80902	OSP Tension Clamps - Self-supporting drop 8 in, fiber-reinforced plastic (FRP) or aramid yarn messenger 6 mm–9 mm (0.25 in–0.35 in)
269-OPH02-D10P7	OSP Tension Clamps - FTTH drop flat cable 3 mm–5 mm (0.12 in–0.2 in)
269-OPH02-D11P2	OSP Tension Clamps - FTTH drop flat cable 3 mm–7 mm (0.12 in–0.3 in)
048-301/TC	OSP Drop Wire Tension Clamp

## OSP Anchor Clamps - Round ADSS cable

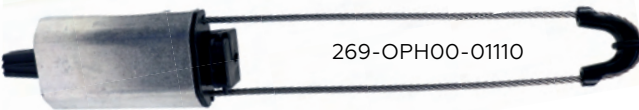

269-OPH00-01110



Item #	Description
269-OPH00-01110	OSP Anchor Clamps - Round ADSS cable <b>8 mm–11 mm (0.3 in–0.4 in)</b>
269-OPH00-01415	OSP Anchor Clamps - Round ADSS cable <b>11 mm–14 mm (0.4 in–0.6 in)</b>

### Features:

- Tension, self-adjusting plastic wedges
- Round ADSS cable construction

### Applications:

- Dead-end support/drop, suspension support

## OSP Hooks

Item #	Description
269-OPH30-011P5	OSP Hooks 1.5 kN (~340 lbf)



## OSP Brackets

Item #	Description
269-OPH10-0115	OSP Brackets 15 kN (~3,370 lbf)
269-OPH10-0304	OSP Brackets 5 kN (~1,120 lbf)



269-OPH10-0115



269-OPH10-0304

## OSP Steel Banding

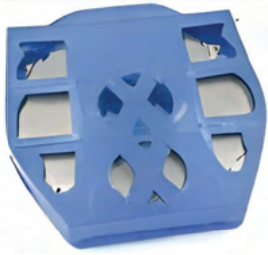

269-OPH20-42050

Item #	Description
269-OPH20-42050	OSP Stainless Steel Banding Strap Roll
269-OPH21-420L	OSP Stainless Steel Banding Strap Buckle L-type
269-OPH21-420T	OSP Stainless Steel Banding Strap Buckle T-type
269-OPH22-0120	OSP Steel Banding Tool Rotary Type
269-OPH22-0220	OSP Steel Banding Tool Jack Type



COPPER BULK CABLE

OPTICAL FIBER BULK CABLE



269-OPH21-420L



269-OPH21-420T



269-OPH22-0120



269-OPH22-0220

## OSP Suspension Clamps

Round ADSS cable



269-OPH01-01204



269-OPH01-01504



269-OPH01-02004

Messenger ("8 in)



269-OPH01-80802

Round drop (two-piece item)



269-OPH01-D0P3

Item #	Description
269-OPH01-01204	OSP Suspension Clamps – Round ADSS, self-supporting, or drop cable 8 mm–12 mm (0.3 in–0.5 in)
269-OPH01-01504	OSP Suspension Clamps – Round ADSS, self-supporting, or drop cable 10 mm–15 mm (0.4 in–0.6 in)
269-OPH01-02004	OSP Suspension Clamps – Round ADSS, self-supporting, or drop cable 15 mm–20 mm (0.6 in–0.8 in)
269-OPH01-80802	OSP Suspension Clamps – Messenger (8 in) – 4 mm–8 mm (0.16 in–0.4 in)
269-OPH01-D0P3	OSP Suspension Clamps – Round drop 2 mm–8 mm (0.08 in–0.4 in)



CABLE MANAGEMENT & RACKS

INDUSTRIAL & HARSH ENVIRONMENTS

# Tools

COPPER BULK CABLE

## Installation Tools

### Cable Preparation Tool – Sheath Cutter

Item #	Description
269-CSC01-CL628	Optical Fiber Cable Sheath Cutter, Circular/Longitudinal, Cable Diameters: 6 mm–28 mm



Cutting modes:  
circular (“ringing”);  
longitudinal (“slitting”);  
midspan/endspan

[Bulk Optical Fiber Cable](#) **P84**

OPTICAL FIBER BULK CABLE

## Maintenance Tools

### LC Plug Insertion/Extraction Tool

Item #	Description
269-SAM01-1A	Optical Fiber Connector Insertion-Extraction Tool LC



#### Features:

- Glass-filled polyphenylene sulfide (PPS).
- Mode of operation: insertion/extraction
- Compatible with LC style connectors, simplex and duplex



CABLE MANAGEMENT & RACKS

## Scissors and Strippers

Item #	Description
269-PAC04-0005	Professional Aramid Fiber Scissors for optical fiber cable preparation
269-PAC05-0006	Optical fiber stripper, 3-step (2 mm–3 mm/0.9 mm/0.25 mm)



#### Features:

- Strips the 0.06–0.12 in. fiber jacket, 0.02–0.04 in. buffer coating, and 0.01 in. coating to expose the 125 micron glass fiber
- Hex wrench included for depth adjustments

#### Features:

- Heavy duty, industrial quality stainless steel serrated edge blades for increased cutting capacity
- Non-slip serrated blades
- Rounded points for extra safety



269-PAC05-0006



269-PAC04-0005

INDUSTRIAL & HARSH ENVIRONMENTS

INSTALLATION, TESTING, MAINTENANCE » Inspection Tools

### Heavy-Duty Field VFL

Item #	Description
269-VFL03	Optical Fiber Visual Fault Locator, Hand-Held, 5-mW, 2.5-mm Adapter



### Optical Fiber Visual Fault Locator, Compact, 5-mW, 2.5-mm Adapter

Item #	Description
269-VFL04	Optical Fiber Visual Fault Locator, Pen-Style, 5-mW, 2.5-mm, Adapter



INSTALLATION, TESTING, MAINTENANCE » Testing Instruments

### Light Source and Power Meter

Item #	Description
269-OLS02-12	Light Source, Wavelengths: 850 nm, 1300 nm
269-OLS02-35	Light Source, Wavelengths: 1310 nm, 1550 nm
269-OPM01-5026	Power Meter, Power Range: -50 dBm-+26 dBm
269-OPM01-7006	Power Meter, Power Range: -70 dBm-+6 dBm
269-PAC02-0001	Portable carrying soft-case bag



269-OLS02 - Light Source    269-OPM01 - Power Meter

**Features:**

- Interface type: 2.5-mm (FC, ST, SC)
- Display: LCD monochrome; backlight mode
- Power supply: batteries 3x AAA 1.5 V

### Test Leads & Test Adapter

Item #	Description
269-PAC11-0002	Optical Fiber Test Lead, 2.5-mm to 1.25-mm Conversion, FC Plug to SC Plug, SX, 50-µm Core, 1 ft, SC SX
269-PAC11-0003	Optical Fiber Test Lead, 2.5-mm to 1.25-mm Conversion, FC Plug to LC Plug, SX, 50-µm Core, 1 ft, LC SX Adapter
269-PAC11-0004	Optical Fiber Test Lead, 2.5-mm to 1.25-mm Conversion, FC Plug to SC Plug, UPC, SX, SM Core, 1 ft, SC SX Adapter
269-PAC11-0005	Optical Fiber Test Lead, 2.5-mm to 1.25-mm Conversion, FC Plug to LC Plug, UPC, SX, SM Core, 1 ft, LC SX Adapter
269-PAC11-0001	Optical Fiber Test Adapter, 2.5-mm to 1.25-mm Conversion, Hybrid, FC Plug to LC Adapter, SX, SM, UPC

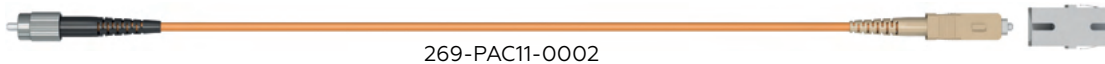

269-PAC11-0002

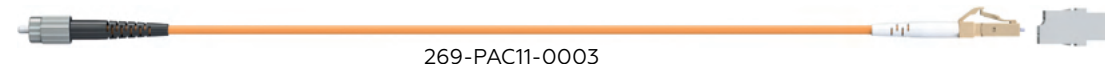

269-PAC11-0003



269-PAC11-0004



269-PAC11-0005



269-PAC11-0001

**VC**  
VERTICAL CABLE

29

28 **H**

**VC**  
VERTICAL CABLE

26

1A-108 1A-109 1A-110 1A-111 1A-112

1A-113 1A-114

42

10

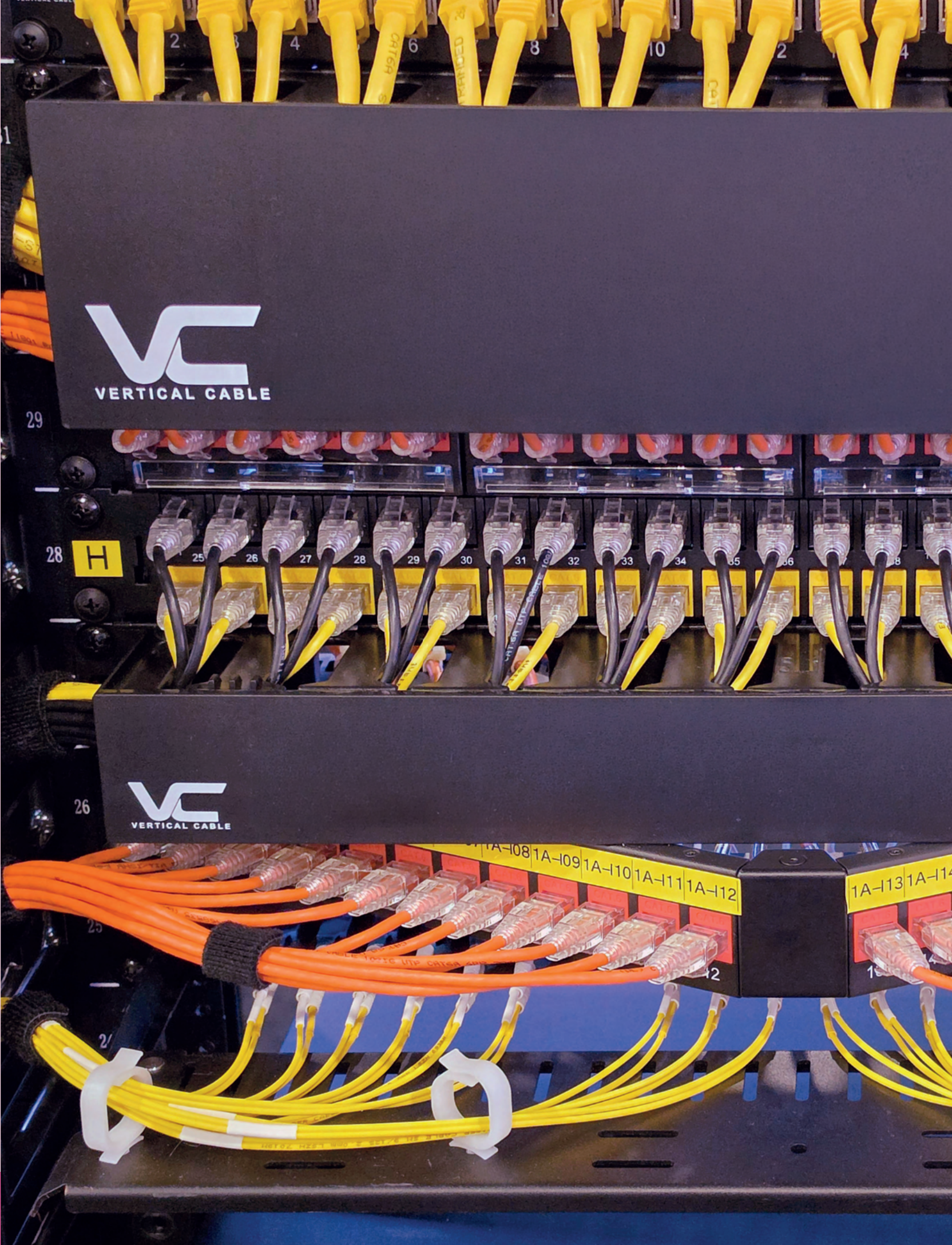

# 3.

## CABLE MANAGEMENT & RACKS

# Raceways & Accessories

COPPER BULK CABLE

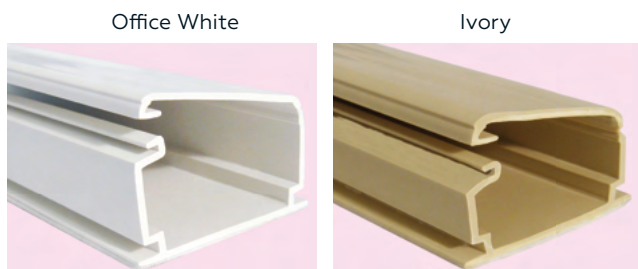

OPTICAL FIBER BULK CABLE



CABLE MANAGEMENT & RACKS



INDUSTRIAL & HARSH ENVIRONMENTS



Available in Ivory and Office white and three sizes

	Item	Office White	Ivory
0.75 in	6 FT Raceway	045-TSR1FW-6A	045-TSR1I-6A
	Splice Cover	045-TSR1FW-14	045-TSR1I-14
	Tee	045-TSR1FW-21-1	045-TSR1I-21-1
	Elbow	045-TSR1FW-25-1	045-TSR1I-25-1
	External Corner	045-TSR1FW-29-1	045-TSR1I-29-1
	Internal Corner	045-TSR1FW-33-1	045-TSR1I-33-1
	End Cap	045-TSR1FW-36	045-TSR1I-36
	Ceiling Drop	045-TSR1FW-50	045-TSR1I-50
1.25 in	6 FT Raceway	045-TSR2FW-6A	045-TSR2I-6A
	Splice Cover	045-TSR2FW-14	045-TSR2I-14
	Tee	045-TSR2FW-21-1	045-TSR2I-21-1
	Elbow	045-TSR2FW-25-1	045-TSR2I-25-1
	External Corner	045-TSR2FW-29-1	045-TSR2I-29-1
	Internal Corner	045-TSR2FW-33-1	045-TSR2I-33-1
	End Cap	045-TSR2FW-36	045-TSR2I-36
	Ceiling Drop	045-TSR2FW-50	045-TSR2I-50
1.75 in	6 FT Raceway	045-TSR3FW-6A	045-TSR3I-6A
	Splice Cover	045-TSR3FW-14	045-TSR3I-14
	Tee	045-TSR3FW-21-1	045-TSR3I-21-1
	Elbow	045-TSR3FW-25-1	045-TSR3I-25-1
	External Corner	045-TSR3FW-29-1	045-TSR3I-29-1
	Internal Corner	045-TSR3FW-33-1	045-TSR3I-33-1
	End Cap	045-TSR3FW-36	045-TSR3I-36
	Ceiling Drop	045-TSR3FW-50	045-TSR3I-50

### Features:

- Tamper resistant, the cover's self-locking, hidden positive latch permits quick re-entry as well as providing a secure installation of premise wire
- Manufactured of UL 94 V-0 rated PVC material
- Fittings incorporate a minimum 1 in bend radius per ANSI/TIA-568.0 and ANSI/TIA-569
- Rubber-based foam tape adhesive with high ultimate bond strength conforms to any surface
- Flexible hinge allows the raceway to endure numerous openings without creating discoloration or stress cracking
- Junction boxes can be used with this raceway for electrical or data outlets
- Measuring 6 FT in length

## Clean Lines for Low Voltage Design.



## Hook and Loop Strap

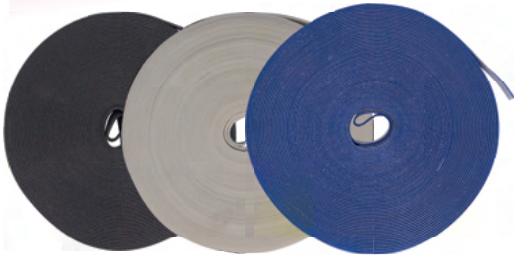

Item #	Description
045-V12/75BK	1/2 in Width Hook and Loop Strap, 75 ft, Black
045-V12/75BL	1/2 in Width Hook and Loop Strap, 75 ft, Blue
045-V12/75WH	1/2 in Width Hook and Loop Strap, 75 ft, White
045-V34/75BK	3/4 in Width Hook and Loop Strap, 75 ft, Black
045-V34/75BL	3/4 in Width Hook and Loop Strap, 75 ft, Blue
045-V34/75WH	3/4 in Width Hook and Loop Strap, 75 ft, White

- o Perfect for mounting, organizing & identification applications
- o Reuse and readjust hook and loop straps multiple times
- o Cut to any length
- o 75 FT rolls



## Standard Cable Ties



Natural

Black

Red



- o 18 or 50 lbf tensile rating
- o Standard or Plenum
- o RoHS-Compliant
- o 100 per bag

Item #	Description
045-CT/18/4BK	4 in Cable Ties, 18 lbf tensile rating, Black
045-CT/18/4NT	4 in Cable Ties, 18 lbf tensile rating, Natural
045-CT/50/8BK	8 in Cable Ties, 50 lbf tensile rating, Black
045-CT/50/8NT	8 in Cable Ties, 50 lbf tensile rating, Natural
045-CT/50/12BK	12 in Cable Ties, 50 lbf tensile rating, Black
045-CT/50/12NT	12 in Cable Ties, 50 lbf tensile rating, Natural
045-CT/50/15BK	15 in Cable Ties, 50 lbf tensile rating, Black
045-CT/50/15NT	15 in Cable Ties, 50 lbf tensile rating, Natural
045-CTP/M50/8R	8 in Cable Ties, Red (PLENUM)
045-CTP/M50/12R	12 in Cable Ties, Red (PLENUM)
045-CTP/M50/15R	15 in Cable Ties, Red (PLENUM)



## Self-Gripping Cable Ties



- o The Double-Sided Self-gripping Tie Wraps feature full surface-area
- o No clipping is necessary, in contrast to the traditional tie wrap
- o Reuse and readjust the Self-gripping Tie Wraps multiple times
- o Perfect for mounting, organizing & identification applications
- o 50 strips per bag

Item #	Description
045-V12/12BK	12 in Self-Gripping Cable Ties, 50 Pack
045-V12/8BK	8 in Self-Gripping Cable Ties, 50 Pack



## Mounting Bases

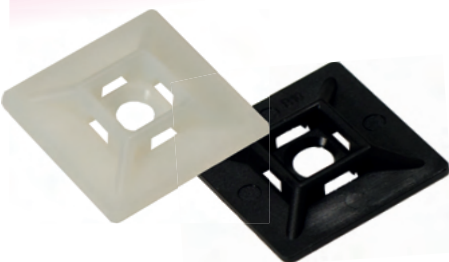

- o Material: Polyamide 6.6 (PA66)
- o Operating Temperature: -40°F +185°F (-40°C+85°C) continuous
- o Flammability: UL 94 V2
- o 100 per bag

Item #	Description
045-MB/A/11/BK	Adhesive Mounting Base, 100 Pack, Black
045-MB/A/11/NT	Adhesive Mounting Base, 100 Pack, Natural
045-MB/S/11/BK	Screw Mounting Base, 100 Pack, Black
045-MB/S/11/NT	Screw Mounting Base, 100 Pack, Natural



# J-Hooks and D Rings

## J-Hooks



048-142/40



048-141/20



048-139/16



048-140/34



048-146/40W



048-145/20W



048-144/16W



048-143/34W



048-156/40AB



048-154/20AB



048-150/34AB

Item #	Description
048-140/34	J-Hook, 3/4 in Galvanized Steel
048-139/16	J-Hook, 1-5/16 in Galvanized Steel
048-141/20	J-Hook, 2 in Galvanized Steel
048-142/40	J-Hook, 4 in Galvanized Steel
048-143/34W	J-Hook, 3/4 in Galvanized Steel, with Bat Wing for 1/4 in Rod
048-144/16W	J-Hook, 1-5/16 in Galvanized Steel, with Bat Wing for 1/4 in Rod
048-145/20W	J-Hook, 2 in Galvanized Steel, with Wing for 1/4 in Rod
048-146/40W	J-Hook, 4 in Galvanized Steel, with #12 Wing for 1/4 in Rod
048-150/34AB	J-Hook, 3/4 in Galvanized Steel, with angle bracket
048-154/20AB	J-Hook, 2 in Galvanized Steel, with with angle bracket
048-156/40AB	J-Hook, 4 in Galvanized Steel, with with angle bracket
048-160/BC	Beam Clamp for J-Hook

### Features:

- Galvanized steel; Rust resistant zinc coating
- Hooks available with wing, which mounts on vertically spanning steel rods
- Winged Hooks feature cable retainer pin
- Wing attachments mount on 1/4 in or 3/8 in rods



048-160/BC

## Distribution D Rings



2 in



3 in



5 in



### Features:

- Aluminum
- Available in multiple sizes
- Used to provide support to vertical and horizontal cable runs

Item #	Description
048-170/D2	Distribution D Ring, 2 in, Aluminum
048-175/D3	Distribution D Ring, 3 in, Aluminum
048-185/D5	Distribution D Ring, 5 in, Aluminum

# Bridle Rings

## Machine Screw Bridle Rings



048-193/MS/1440

048-192/MS/1420

048-191/MS/1412

048-190/MS/1414



Item #	Description
048-190/MS/1414	Bridle Rings with Machine screw thread 1/4-20 x 1-1/4 in
048-191/MS/1412	Bridle Rings with Machine screw thread 1/4-20 x 1-1/2 in
048-192/MS/1420	Bridle Rings with Machine screw thread 1/4-20 x 2 in
048-193/MS/1440	Bridle Rings with Machine screw thread 1/4-20 x 4 in

## Wood Screw Bride Rings

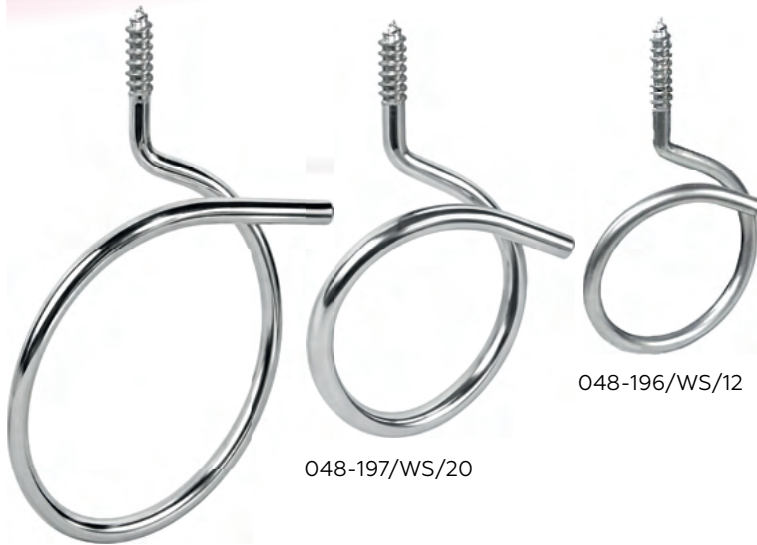

048-198/WS/40

048-197/WS/20

048-196/WS/12

048-195/WS/14

### Features:

- o Aluminum
- o Available in multiple sizes
- o Used to provide support to vertical and horizontal cable runs



Item #	Description
048-195/WS/14	Bridle Rings with Wood Screw thread 1/4-20 x 1-1/4 in
048-196/WS/12	Bridle Rings with Wood Screw thread 1/4-20 x 1-1/2
048-197/WS/20	Bridle Rings with Wood Screw thread 1/4-20 x 2 in
048-198/WS/40	Bridle Rings with Wood Screw thread 1/4-20 x 4 in

## Snap-on Bridle Ring Cable Saddle



048-150/34AB



Item #	Description
048-211/BRS/20	Snap-on Bridle Ring Cable Saddle, 2-in, Plastic, Yellow

Racks & Accessories

Horizontal Wire Managers - Double-sided

044-2391/DS/1U



1 RMU

Height 1.75 in Width 19 in Depth 4 in Weight 1.5 lb

044-2392/DS/2U



2 RMU

Height 3 in Width 19 in Depth 6 in Weight 3 lb

Item #	Description
044-2391/DS/1U	1 RMU, Horizontal Wire Manager Double-Sided
044-2392/DS/2U	2 RMU, Horizontal Wire Manager Double-Sided



Horizontal Wire Managers - Single-sided

044-2393/DC/1U

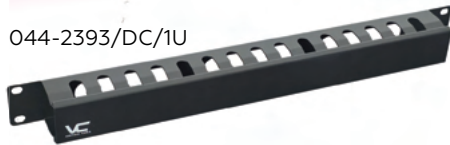

1 RMU

Height 1 3/4 in Width 19 in Depth 3 in Weight 2 lb

044-2394/DC/2U

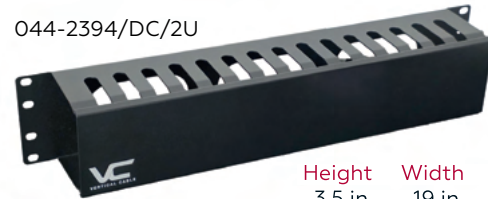

2 RMU

Height 3.5 in Width 19 in Depth 3 in Weight 2 lb

044-2495/DCP/1U



1 RMU

Height 1.75 in Width 19 in Depth 4 in Weight 1.5 lb

044-2496/DCP/2U



2 RMU

Height 3 in Width 19 in Depth 6 in Weight 3 lb

Item #	Description
044-2393/DC/1U	1 RMU, Horizontal Wire Manager - Metal
044-2394/DC/2U	2 RMU, Horizontal Wire Manager - Metal
044-2495/DCP/1U	1 RMU, Horizontal Wire Manager - Plastic
044-2496/DCP/2U	2 RMU, Horizontal Wire Manager - Plastic

- o Fits standard 19 in Racks or Wall-Mounts
- o Steel Main Mount
- o Plastic Wire Management Fingers
- o Plastic Covers
- o Comes with x4 M6 screws (cage nuts not included)

044-2393/1U



1 RMU

Height 1 3/4 in Width 19 in Depth 3 in Weight 1 lb

Item #	Description
044-2393/1U	1 RMU, Horizontal Wire Manager - with metal holders, no cover



# Support Bracket, Screws, Washers & Cage Nuts, Power Strip

## 1 RMU, 2 RMU Patch Panel Support Bracket

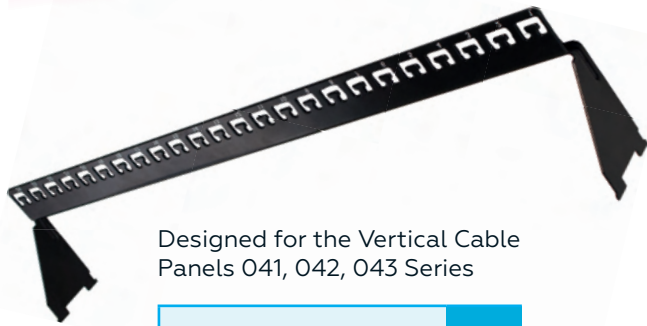

Designed for the Vertical Cable Panels 041, 042, 043 Series

[Patch Panels](#)

P64

Item #	Description
044-2396/1U	1 RMU, Patch Panel Support Bracket - For 24 Port Patch Panel
044-2397/2U	2 RMU, Patch Panel Support Bracket - For 48 Port Patch Panel

### Features:

- Durable black powder-coated finish
- Designed to fit Vertical Cable patch panels
- Heavy-duty steel construction



## 1 RMU, 2 RMU Wall-Mount Brackets

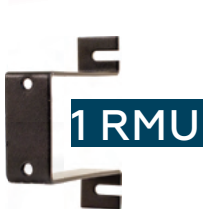

046-388/S



046-389/S



Comes with mounting screws

Item #	Description
046-388/S	1 RMU Mounting Bracket, 1 piece
046-389/S	2 RMU Mounting Bracket, 1 piece



## Screws, Washers & Cage Nuts



047-WSN-0050



047-WSN-0600



047-WSN-0070

Item #	Description
047-WSN-0050	x50 M6 Screws, x50 Washers & x50 Nuts - Length 12 mm (0.47 inches)
047-WSN-0600	x50 #12-24 US Style Screws & Washers - Length 16 mm (0.62 inches)
047-WSN-0070	x50 #10-32 US Style Screws & Washers - Length 20 mm (0.75 inches)



## 1 RMU, 19 in Power Strip with Circuit Breaker



Height	Width	Depth	Weight	Cord Length
1.77 in	19 in	1.77 in	2 lb	6 FT



PROTECTIVE SWITCH COVER

### Features:

- 1 RMU, 19-inch rack-mount design
- 8 grounded outlets for power distribution
- 15A, 125V rating
- Durable metal housing
- Protective switch cover to prevent accidental shutdown

Item #	Description
047-WPS-2000	1 RMU, 19 in Power Strip with Circuit Breaker



COPPER BULK CABLE

OPTICAL FIBER BULK CABLE

CABLE MANAGEMENT & RACKS

INDUSTRIAL & HARSH ENVIRONMENTS

Racks & Accessories » VERTICAL WALL-MOUNT RACK

1 RMU, 2 RMU, 3 RMU, 4 RMU Vertical Wall-Mount Rack / Bracket

Features:

- o Durable aluminum construction
- o Flush mount for wall or under-desk use
- o Pre-drilled for #12-24 screws
- o Includes mounting hardware
- o Fits standard 19-inch rack equipment

Item #

Description

047-WVR-1000	1 RMU Vertical Wall-Mount Rack / Bracket
047-WVR-2000	2 RMU Vertical Wall-Mount Rack / Bracket
047-WVR-3000	3 RMU Vertical Wall-Mount Rack / Bracket
047-WVR-4000	4 RMU Vertical Wall-Mount Rack / Bracket

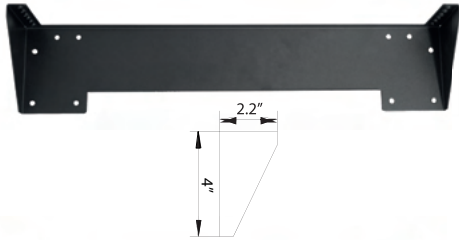

1 RMU

Height	Width	Depth	Weight	Capacity
4 in	19 in	2.2 in	1.5 lb	11 lb

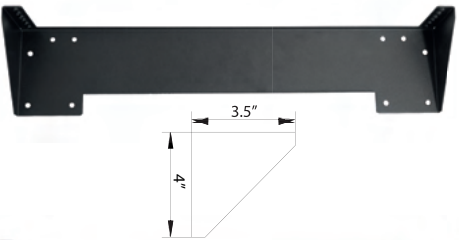

2 RMU

Height	Width	Depth	Weight	Capacity
4 in	19 in	3.5 in	1.7 lb	15 lb

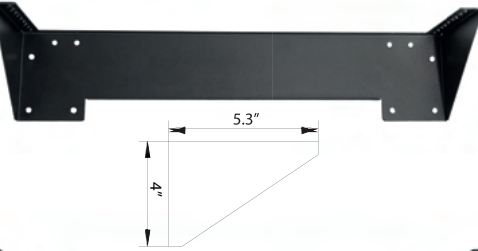

3 RMU

Height	Width	Depth	Weight	Capacity
4 in	19 in	5.3 in	1.98 lb	17.6 lb

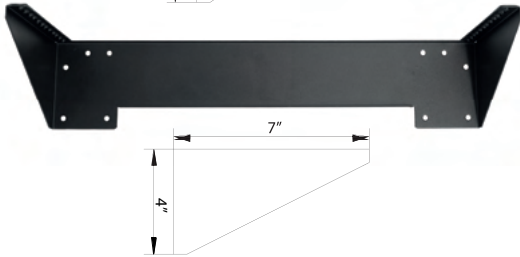

4 RMU

Height	Width	Depth	Weight	Capacity
4 in	19 in	7 in	2.2 lb	22 lb

Illustration of panel-mounted installation

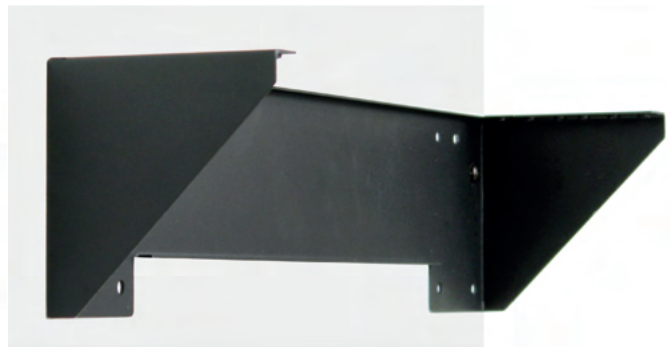

## Hinged Type - Adjustable Wall-Mount Brackets



**Features:**

- Hinged design for easy access
- Adjustable depth from 10 to 13 in
- Cold-rolled steel (SPCC), 2 mm thickness (14 gauge)
- Includes M4 screws

Item #	Description
046-388/E	1 RMU, Hinge Type Adjustable Wall-Mount Bracket
046-389/E	2 RMU, Hinge Type Adjustable Wall-Mount Bracket
046-390/E	4 RMU, Hinge Type Adjustable Wall-Mount Bracket



## Hinged Type Wall-Mount Brackets



**Features:**

- Heavy-duty steel construction
- Static-resistant black finish
- Includes M4 screws

Item #	Description
046-388	1 RMU, Hinged Type Wall-Mount Bracket
046-389	2 RMU, Hinged Type Wall-Mount Bracket
046-390	4 RMU, Hinged Type Wall-Mount Bracket



## Surface-Mount Equipment Brackets Award-Winning Compact Design

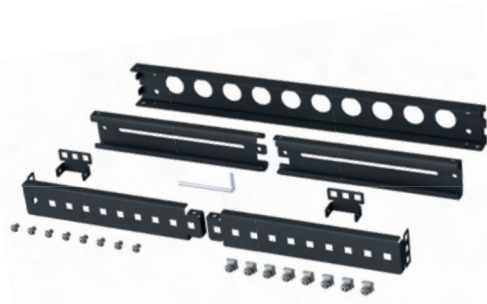

**Features:**

- Eight depth levels, 1-in step
- Max equipment unit depth: 17.5 in
- M6 cage nuts/screws

Item #	Description
254-EMB01-B1B1	1 RMU Surface-Mount Equipment Bracket, Field-Configurable, 19-in. Compact design.



# Open Rack Enclosures

## Open Racks - 2-Post and 4-Post

COPPER BULK CABLE

OPTICAL FIBER BULK CABLE

CABLE MANAGEMENT & RACKS

INDUSTRIAL & HARSH ENVIRONMENTS

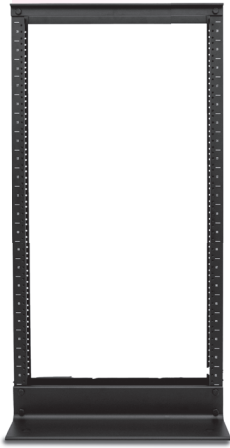

### 2 Post, 20 RMU

047-WOS-0220

- Heavy-duty steel construction
- Ships unassembled
- Easy assembly
- Includes hardware and mounting set (28x #12-24 screws\*, washers)

\*SKU: 047-WSN-0600



Height	Width	Depth	Base Dim.	Weight	Capacity
40 in	20 in	14 in	14x20.27 in	21 lb	440 lb

[Patch Panels](#)

[P64](#)

[Fiber Enclosures](#)

[P93](#)

[Blank Filler Panels](#)

[P66](#)

Height	Width	Base Dim.	Weight	Capacity
84 in	20.25 in	15x20.25 in	28 lb	440 lb

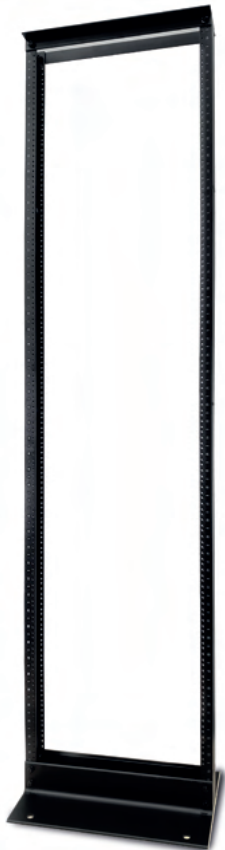

### 2 Post, 45 RMU

047-WOS-0245

- Heavy-duty steel construction
- Ships unassembled
- Easy assembly
- Includes hardware and mounting set (28x #12-24 screws\*, washers)

\*SKU: 047-WSN-0600



[Shelves](#)

[P128](#)

[Horizontal Wire Managers](#)

[P126](#)

#### Features:

- Compatible with standard 19-inch rack equipment
- Rigid steel frame with unit markings
- Static-resistant powder-coated finish
- Pre-drilled for #12-24 screws

Height	Width	Depth	Weight	Capacity
84 in	20 in	24-36 in	61 lb	1322 lb

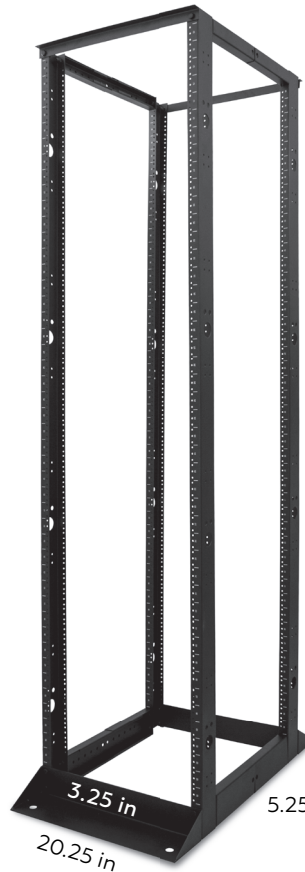

### 4 Post, 45 RMU

047-WOS-0445

- Heavy-duty steel construction
- Ships unassembled
- Easy assembly
- Adjustable depth (24 to 36 inches)
- 2 millimeter steel construction
- Includes hardware and mounting set (40x #12-24 screws\*, washers)
- Ships in two boxes (poles and base with hardware)

\*SKU: 047-WSN-0600



Side View  
Adjustable depth 20 in-36 in



Item #	Description
047-WOS-0220	20 RMU, 2 post, 19 in Open Rack
047-WOS-0245	45 RMU, 2 post, 19 in Open Rack
047-WOS-0445	45 RMU, 4 post, 19 in Open Rack

# Wire Managers

## Vertical Wire Managers

### 2 Post, 20 RMU

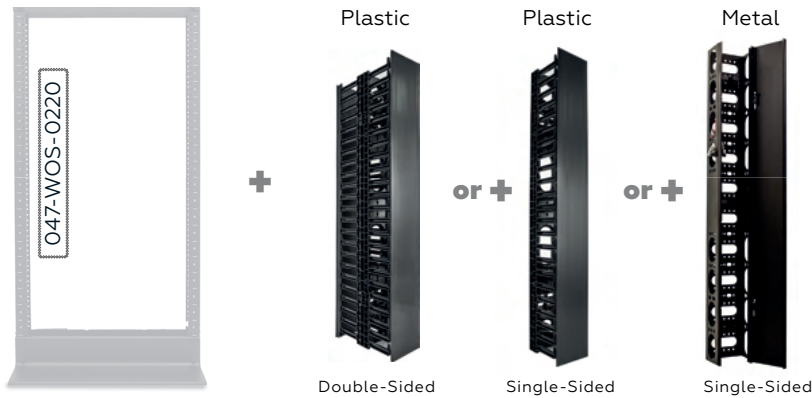

#### Metal Manager

Height	Width	Depth	Weight
32 in	3.7 in	3 in	7 lb

Item #	Description
047-WVM-2010	20 RMU, Vertical Wire Manager, Metal

- Features:**
- Heavy-Duty Steel Frame
  - Black Powder-Coated Finish



### 4 Post, 45 RMU

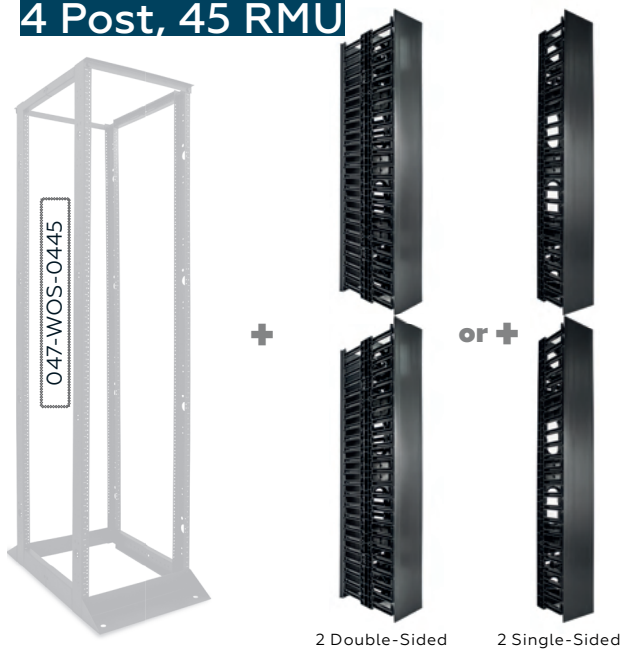

#### Plastic Managers

Height	Width	Depth	Type
40-8/8 in	5 in	6-5/16 in	Single-Sided
40-3/8 in	5 in	12 in	Double-Sided

Item #	Description
047-VMF-4501	45 RMU, Vertical Wire Manager, Plastic, Single-Sided
047-VMF-4502	45 RMU, Vertical Wire Manager, Plastic, Double-Sided
047-VMF-4500/B	Metal Brackets for 047-VMF Series

- Features:**
- High-quality plastic construction (fingerprint-resistant finish)
  - Removable cover for easy access
  - Flexible fingers for smooth cable routing
  - Left or right side rack mounting (L/R)
  - Fits most standard relay racks
  - Two sections included (2 × 22.5 RMU)
  - Use one or combine for full 45 RMU
  - Includes mounting hardware (screws + metal ears)

### 2 Post, 45 RMU



Note: One unit consists of 2 pieces (Part 1 and Part 2 on a diagram). Stacked together they form 45-RMU height

EASIER SHIPPING

LIGHT WEIGHT

stacks on

# Wall-Mount Racks

## Rack It Right – Choose the Best Fit for Your Space.

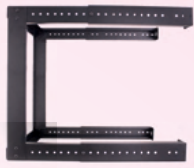

Part Number	047-WFM	047-WFJ	047-WTH	047-WSM
<b>Style</b>	Adjustable Depth	Fixed Depth	Adjustable Depth Wall-mounting vertical brackets	Adjustable Depth - Swing-out Wall-mounting vertical brackets
<b>Thread Type</b>	Cage nuts with M6 screws	Cage nuts with M6 screws	Pre-drilled holes for #12-24 screws	Cage nuts with M6 screws
<b>Depth</b>	18-30 in	18 in	18-30 in	18-30 in
<b>Capacity</b>	Up to 110 lb	Up to 66 lb	Up to 150 lb	Up to 65 lb
<b>RMU spaces</b>	6, 8, 9, 12, 16, 20 RMU	6, 8, 9, 12, 16, 20 RMU	6, 8, 9, 12, 16, 20 RMU	6, 8, 9, 12, 16, 20 RMU

### 047-WFM SERIES Open Fixed Rack - Adjustable depth

#### 6 RMU

047-WFM-0626

Height	Width	Mounting Width	Depth	Weight	Capacity
14.29 in	20 in	19 in	18-30 in	17.6 lb	33/110 lb

#### 8 RMU

047-WFM-0826

Height	Width	Mounting Width	Depth	Weight	Capacity
17.8 in	20 in	19 in	18-30 in	22 lb	44/110 lb

#### 9 RMU

047-WFM-0926

Height	Width	Mounting Width	Depth	Weight	Capacity
19.6 in	20 in	19 in	18-30 in	22.7 lb	55/110 lb

#### 12 RMU

047-WFM-1226

Height	Width	Mounting Width	Depth	Weight	Capacity
24.8 in	20 in	19 in	18-30 in	23.1 lb	66/110 lb

#### 16 RMU

047-WFM-1626

Height	Width	Mounting Width	Depth	Weight	Capacity
31.77 in	20 in	19 in	18-30 in	24.9 lb	66/110 lb

#### 20 RMU

047-WFM-2026

Height	Width	Mounting Width	Depth	Weight	Capacity
38.80 in	20 in	19 in	18-30 in	25.8 lb	77/110 lb

- Fits standard 19-inch rack equipment
- 2 millimeter steel construction
- Open-frame wall-mount
- Includes mounting set (\*M6 screws, cage nuts, washers)  
6-9 RMU: 12x | 12-20 RMU: 20x
- Static-resistant powder-coated finish
- Ships unassembled with hardware

\*SKU: 047-WSN-0050



Item #	Description
047-WFM-0626	6 RMU Open Wall-Mount - Adjustable depth
047-WFM-0826	8 RMU Open Wall-Mount - Adjustable depth
047-WFM-0926	9 RMU Open Wall-Mount - Adjustable depth
047-WFM-1226	12 RMU Open Wall-Mount - Adjustable depth
047-WFM-1626	16 RMU Open Wall-Mount - Adjustable depth
047-WFM-2026	20 RMU Open Wall-Mount - Adjustable depth



## 047-WFJ SERIES Open Frame Rack

### 6 RMU 047-WFJ-0653

Height 14.25 in    Width 20 in    Depth 18 in    Weight 15 lb    Capacity 26 lb

### 8 RMU 047-WFJ-0853

Height 17.75 in    Width 20 in    Depth 18 in    Weight 15.6 lb    Capacity 33 lb

### 9 RMU 047-WFJ-0953

Height 19.50 in    Width 20 in    Depth 18 in    Weight 15.7 lb    Capacity 44 lb

### 12 RMU 047-WFJ-1253

Height 24.75 in    Width 20 in    Depth 18 in    Weight 17.25 lb    Capacity 55 lb

### 16 RMU 047-WFJ-1653

Height 31.75 in    Width 20 in    Depth 18 in    Weight 18.5 lb    Capacity 66 lb

### 20 RMU 047-WFJ-2053

Height 38.80 in    Width 20 in    Depth 18 in    Weight 20.7 lb    Capacity 66 lb



- o Fits standard 19-inch rack equipment
- o Open-frame steel wall-mount
- o Includes mounting set (\*M6 screws, cage nuts, washers)  
6-9 RMU: 12x | 12-20 RMU: 20x
- o Static-resistant powder-coated finish
- o Ships unassembled with hardware
- o Up to 66 pounds load capacity

\*SKU: 047-WSN-0050

Item #	Description
047-WFJ-0653	6 RMU Wall-Mount Open Frame Rack
047-WFJ-0853	8 RMU Wall-Mount Open Frame Rack
047-WFJ-0953	9 RMU Wall-Mount Open Frame Rack
047-WFJ-1253	12 RMU Wall-Mount Open Frame Rack
047-WFJ-1653	16 RMU Wall-Mount Open Frame Rack
047-WFJ-2053	20 RMU Wall-Mount Open Frame Rack



## Wall-Mount Racks Applications:



**01**  
AV & STAGE GEAR



**02**  
OFFICE NETWORK  
INFRASTRUCTURE



**03**  
TELECOM &  
DATA CLOSETS



**04**  
RETAIL /  
HOSPITALITY TECH



**05**  
SECURITY & ACCESS  
SYSTEMS



**06**  
HOME AUTOMATION /  
SMART SYSTEMS



**07**  
EDUCATION &  
TRAINING FACILITIES



**08**  
HEALTHCARE  
ENVIRONMENTS

Racks & Accessories » 047-WTH SERIES

Open Rack - Fixed Frame, Adjustable depth - High Capacity

6 RMU

047-WTH-0618

Height	Width	Depth	Weight	Capacity
14.25 in	20 in	18-30 in	23.15 lb	150 lb

8 RMU

047-WTH-0818

Height	Width	Depth	Weight	Capacity
17.75 in	20 in	18-30 in	24.5 lb	150 lb

9 RMU

047-WTH-0918

Height	Width	Depth	Weight	Capacity
19.5 in	20 in	18-30 in	25.4 lb	150 lb

12 RMU

047-WTH-1218

Height	Width	Depth	Weight	Capacity
24.75 in	20 in	18-30 in	27.4 lb	150 lb

16 RMU

047-WTH-1618

Height	Width	Depth	Weight	Capacity
31.75 in	20 in	18-30 in	30 lb	150 lb

20 RMU

047-WTH-2018

Height	Width	Depth	Weight	Capacity
38.8 in	20 in	18-30 in	32.8 lb	150 lb

Features:

- o Fits standard 19-inch rack equipment
  - o 2 millimeter steel construction
  - o Open-frame wall-mount
  - o Includes mounting set (#12-24screws\*, flat washers) 6 RMU: 12x | 8 RMU: 12x | 9 RMU: 12x | 12 RMU: 20x | 16 RMU: 20x | 20 RMU: 20x
- \*SKU: 047-WSN-0600



Item #	Description
047-WTH-0618	6 RMU Open Wall-Mount - Adjustable depth - Fixed frame
047-WTH-0818	8 RMU Open Wall-Mount - Adjustable depth - Fixed frame
047-WTH-0918	9 RMU Open Wall-Mount - Adjustable depth - Fixed frame
047-WTH-1218	12 RMU Open Wall-Mount - Adjustable depth - Fixed frame
047-WTH-1618	16 RMU Open Wall-Mount - Adjustable depth - Fixed frame
047-WTH-2018	20 RMU Open Wall-Mount - Adjustable depth - Fixed frame



One Rack. Endless Applications.

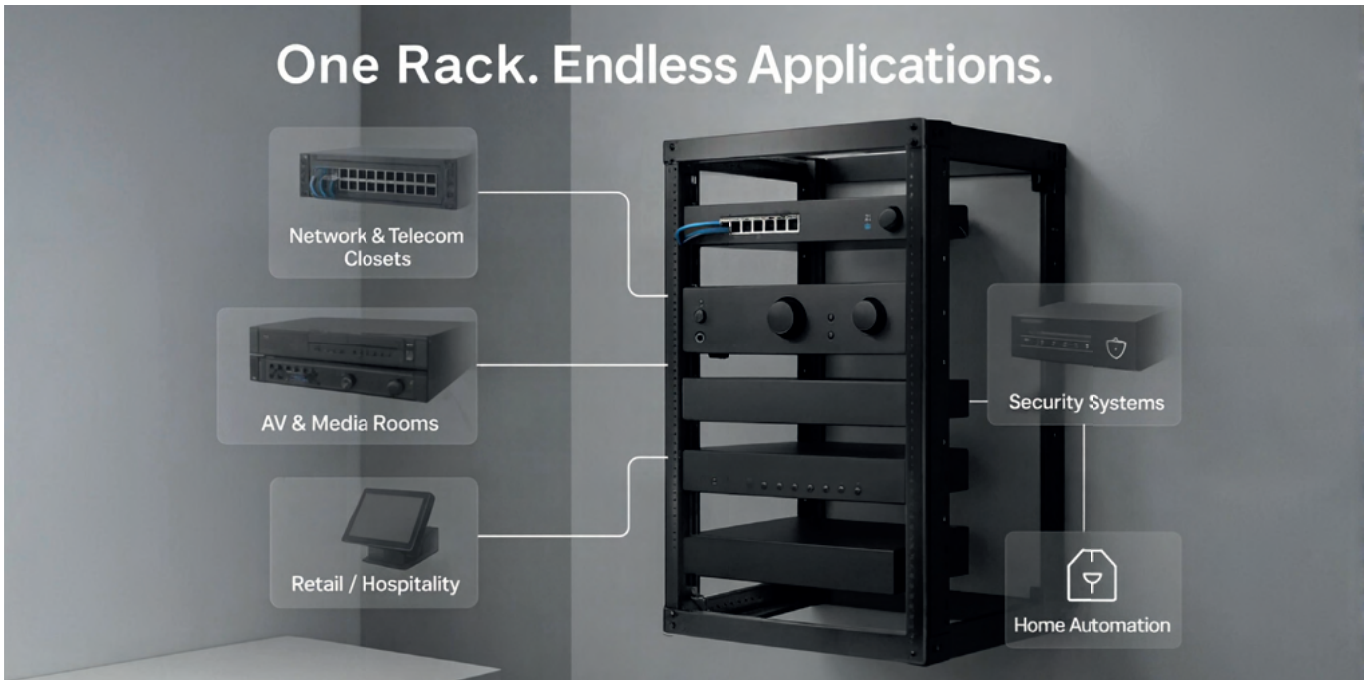

## Open Rack - Swing Out, Adjustable

6 RMU					
047-WSM-0626					
Height	Width	Depth	Weight	Capacity	
16.4 in	21.65 in	18-30 in	25 lb	25 lb (open position) 65 lb (close position)	

8 RMU					
047-WSM-0826					
Height	Width	Depth	Weight	Capacity	
19.9 in	21.65 in	18-30 in	27 lb	25 lb (open position) 65 lb (close position)	

9 RMU					
047-WSM-0926					
Height	Width	Depth	Weight	Capacity	
21.70 in	21.65 in	18-30 in	27.5 lb	33 lb (open position) 65 lb (close position)	

12 RMU					
047-WSM-1226					
Height	Width	Depth	Weight	Capacity	
26.9 in	21.65 in	18-30 in	29.1 lb	33 lb (open position) 65 lb (close position)	

16 RMU					
047-WSM-1626					
Height	Width	Depth	Weight	Capacity	
33.9 in	21.65 in	18-30 in	31.9 lb	44 lb (open position) 65 lb (close position)	

20 RMU					
047-WSM-2026					
Height	Width	Depth	Weight	Capacity	
40.9 in	21.65 in	18-30 in	32.6 lb	44 lb (open position) 65 lb (close position)	

**Features:**

- Reversible swing-out design (left/right)
- Fits standard 19-inch rack equipment
- Includes mounting set (\*M6 screws, flat washers)  
6-9 RMU: 12x | 12-20 RMU: 20x
- Adjustable depth from 18 to 30 inches
- Static-resistant powder-coated finish
- Ships unassembled with hardware

\*SKU: 047-WSN-0050



Item #	Description
047-WSM-0626	6 RMU Open Wall-Mount - Adjustable depth - Swing Out
047-WSM-0826	8 RMU Open Wall-Mount - Adjustable depth - Swing Out
047-WSM-0926	9 RMU Open Wall-Mount - Adjustable depth - Swing Out
047-WSM-1226	12 RMU Open Wall-Mount - Adjustable depth - Swing Out
047-WSM-1626	16 RMU Open Wall-Mount - Adjustable depth - Swing Out
047-WSM-2026	20 RMU Open Wall-Mount - Adjustable depth - Swing Out



### With Open Racks Our Customers usually buy these products:



[Blank Patch Panels](#) **P66**



[DIN-Rail adapter bracket](#) **P151**



[Power Strip](#) **P127**



[Horizontal Wire Manager](#) **P126**



[CAT5E Patch Panels](#) **P64**



[Optical Fiber Enclosures](#) **P93**

## Racks &amp; Accessories » 047-WWM SERIES

## Side Panel Access

**6 RMU**

047-WWM-0660

Height	Width	Depth	Mounting Depth	Weight	Capacity
14.57 in	23.62 in	17.72 in	15.7 in	32 lb	132 lb

**9 RMU**

047-WWM-0960

Height	Width	Depth	Mounting Depth	Weight	Capacity
19.69 in	23.62 in	17.72 in	15.7 in	40 lb	132 lb

**12 RMU**

047-WWM-1260

Height	Width	Depth	Mounting Depth	Weight	Capacity
25 in	23.62 in	17.72 in	15.7 in	53 lb	132 lb

**Features:**

- Durable design with a built-in cooling fan
  - Fits standard 19-inch rack equipment
  - Dust-protective glass front door with lock
  - Ideal for servers, storage, and AV equipment
  - Side panels open for easy access (no lock)
  - Ships fully assembled with hardware
  - Includes mounting set (\*M6 screws, cage nuts, washers)
- 6 RMU: 12x | 9 RMU: 12x | 12 RMU: 20x
- \*SKU: 047-WSN-0050

**Applications:**

- Small to Mid-Sized Network Closets
- Retail and Branch Office Installations
- AV Distribution and Patch Panel Housing
- Surveillance and Security Equipment
- Education and Campus Infrastructure

Item #	Description
047-WWM-0660	6 RMU Wall-Mount Enclosure - Side Access
047-WWM-0960	9 RMU Wall-Mount Enclosure - Side Access
047-WWM-1260	12 RMU Wall-Mount Enclosure - Side Access



## Swing Out



047-WHS-1260

**12 RMU**

047-WHS-1270

Height	Width	Depth	Usable Depth	Weight	Capacity
25 in	24 in	24 in	15.75 in	68 lb	132 lb
Height	Width	Depth	Usable Depth	Weight	Capacity
25 in	24 in	31 in	22.5 in	67 lb	132 lb



047-WHS-1560

**15 RMU**

047-WHS-1570

Height	Width	Depth	Usable Depth	Weight	Capacity
30 in	24 in	24 in	15.75 in	70.5 lb	132 lb
Height	Width	Depth	Usable Depth	Weight	Capacity
30 in	24 in	31 in	22.5 in	81.5 lb	132 lb



047-WHS-2060

**20 RMU**

047-WHS-2070

Height	Width	Depth	Usable Depth	Weight	Capacity
39 in	24 in	24 in	15.75 in	85.5 lb	132 lb
Height	Width	Depth	Usable Depth	Weight	Capacity
39 in	24 in	31 in	22.5 in	98.5 lb	132 lb

### Features:

- Durable design with a built-in cooling fan
- Fits standard 19-inch rack equipment
- Dust-protective glass front door with lock
- Locking side doors for secure access
- Reversible front door hinge
- Ships assembled with hardware included
- Includes mounting set (\*M6 screws, cage nuts, washers)

\*SKU: 047-WSN-0050

### Applications:

- Small to mid-sized network closets and telecom rooms
- Commercial surveillance systems
- Industrial IT enclosures
- Retail back office setups
- Any environment requiring secure, swing-out wall-mounted access

Built-in cooling fan



Item #	Description
047-WHS-1260	12 RMU Wall-Mount Swing-out Enclosure, 24 in Depth
047-WHS-1560	15 RMU Wall-Mount Swing-out Enclosure, 24 in Depth
047-WHS-2060	20 RMU Wall-Mount Swing-out Enclosure, 24 in Depth
047-WHS-1270	12 RMU Wall-Mount Swing-out Enclosure, 31 in Depth
047-WHS-1570	15 RMU Wall-Mount Swing-out Enclosure, 31 in Depth
047-WHS-2070	20 RMU Wall-Mount Swing-out Enclosure, 31 in depth



# Network and Server Cabinets

COPPER BULK CABLE

OPTICAL FIBER BULK CABLE

CABLE MANAGEMENT & RACKS

INDUSTRIAL & HARSH ENVIRONMENTS

## Network Cabinets - 047-NCA Series

### 27 RMU

047-NCA-2766

Height	Width	Depth	Usable Depth	Color	Weight	Capacity
54.5 in	24 in	24 in	20 in	Black	150 lb	2200 lb

### 37 RMU

047-NCA-3766

Height	Width	Depth	Usable Depth	Color	Weight	Capacity
72 in	24 in	24 in	20 in	Black	193 lb	2200 lb

### 42 RMU

047-NCA-4266

Height	Width	Depth	Usable Depth	Color	Weight	Capacity
82 in	24 in	24 in	20 in	Black	218 lb	2200 lb

#### Features:

- o Durable design with two built-in cooling fans
- o Fits standard 19-inch rack equipment
- o Dust-protective glass front door with lock
- o Locking side doors for secure access
- o Caster wheels and leveling feet for stability
- o Vented top and bottom panels for airflow
- o Removable side panels for easy access
- o Steel construction
- o Ships assembled with hardware included
- o Includes M6 screws, washers, and cage nuts (047-WSN-0050)



Item #	Description
047-NCA-2766	27 RMU Rack Space Network Cabinet
047-NCA-3766	37 RMU Rack Space Network Cabinet
047-NCA-4266	42 RMU Rack Space Network Cabinet



## Server Cabinet - 047-SRD Series

### 37 RMU

047-SRD-3768

Height	Width	Depth	Usable Depth	Color	Weight	Capacity
72 in	24 in	31.5 in	25.6 in	Black	194 lb	2204 lb

### 42 RMU

047-SRD-4268

Height	Width	Depth	Usable Depth	Color	Weight	Capacity
82 in	24 in	31.5 in	25.6 in	Black	306 lb	2204 lb

#### Features:

- o Durable design with four built-in cooling fans
- o Fits standard 19-inch rack equipment
- o Steel mesh front door with lock
- o Removable side panels for easy access (no lock)
- o Caster wheels and leveling feet for stability
- o Vented top and bottom panels for airflow
- o Steel construction
- o Ships assembled with hardware included
- o Includes M6 screws, washers, and cage nuts (047-WSN-0050)



Item #	Description
047-SRD-3768	37 RMU Rack Space Network Server Cabinet
047-SRD-4268	42 RMU Rack Space Network Server Cabinet



# DVR Lockbox

## 15, 18, 21, 24 inches DVR Lockbox

**15 in** 047-DVR-1515

Height 5 in Width 15 in Depth 15 in Weight 14 lb

**18 in** 047-DVR-1818

Height 5 in Width 18 in Depth 18 in Weight 22 lb

**21 in** 047-DVR-2121

Height 8 in Width 21 in Depth 21 in Weight 32 lb

**24 in** 047-DVR-2124

Height 8 in Width 21 in Depth 24 in Weight 35.5 lb

### Features:

- Heavy-duty steel construction
- Built-in cooling fan
- Lockable front panel
- Ships fully assembled

### Applications:

- Surveillance DVR/NVR Equipment Protection
- Commercial & Retail Security Systems
- Home Surveillance & Smart Home Hubs
- Network Equipment Housing
- Access Control & Alarm Panel Storage



Front View



Rear View

Item #	Description
047-DVR-1515	15 inch DVR Security Lockbox (15 in depth)
047-DVR-1818	18 Inch DVR Security Lockbox (18 in depth)
047-DVR-2121	21 Inch DVR Security Lockbox (21 in depth)
047-DVR-2124	21 Inch DVR Security Lockbox (24 in depth)



## Horizontal DVR Mounting Bracket

047-DVR-H

Height 12 in Width 21 in Depth 21 in Weight 7.1 lb



047-DVR-V

Height 21 in Width 8 in Depth 8 in Weight 6.3 lb



### Features:

- Durable black powder-coated finish
- Includes mounting hardware



Item #	Description
047-DVR-H	Horizontal DVR Mounting Bracket
047-DVR-V	Vertical DVR Mounting Bracket



# Shelves

COPPER BULK CABLE

## 1 RMU, 2 RMU & 3 RMU 19 in Single-Sided Vented Shelf



### 1 RMU

Height	Width	Depth	Weight	Capacity
1.75 in	19 in	12 in	3.7 lb	20 lb



### 3 RMU

Height	Width	Depth	Weight	Capacity
5.25 in	19 in	15.75 in	4.1 lb	37 lb



### 2 RMU

Height	Width	Depth	Weight	Capacity
3.50 in	19 in	15.75 in	3.9 lb	37 lb



#### Features:

- High-quality SPCC cold rolled steel construction
- One-piece 19-inch vented shelf
- Fits standard 19-inch racks and wall-mounts
- Ideal for server and network applications
- Includes mounting set (\*M6 screws, cage nuts, washers) 1-3 RMU: 4x
- Up to 37 lb load capacity

Item #	Description
047-WVS-1300	1 RMU, 19 in Single-Sided Vented Shelf
047-WVS-2400	2 RMU, 19 in Single-Sided Vented Shelf
047-WVS-3400	3 RMU, 19 in Single-Sided Vented Shelf

\*SKU: 047-WSN-0050

OPTICAL FIBER BULK CABLE

## 1 RMU, 2 RMU & 3 RMU 19 in Single-Sided Non-Vented Shelf



### 1 RMU

Height	Width	Depth	Weight	Capacity
1.75 in	19 in	12 in	3.9 lb	30.8 lb



### 3 RMU

Height	Width	Depth	Weight	Capacity
5.25 in	19 in	15.63 in	4.9 lb	44 lb



### 2 RMU

Height	Width	Depth	Weight	Capacity
3.50 in	19 in	15.70 in	4.4 lb	44 lb



#### Features:

- High-quality SPCC cold rolled steel construction
- One-piece 19-inch non-vented shelf
- Fits standard 19-inch racks and wall-mounts
- Includes mounting set (\*M6 screws, cage nuts, washers) 1-3 RMU: 4x
- Up to 44 pounds load capacity
- Ideal for network and server equipment

Item #	Description
047-WSS-1300	1 RMU, 19 in Single-Sided Non-Vented Shelf
047-WSS-2400	2 RMU, 19 in Single-Sided Non-Vented Shelf
047-WSS-3400	3 RMU, 19 in Single-Sided Non-Vented Shelf

\*SKU: 047-WSN-0050

CABLE MANAGEMENT & RACKS

INDUSTRIAL & HARSH ENVIRONMENTS

## 1 RMU 19-inch Vented Four-Point Sliding Shelf

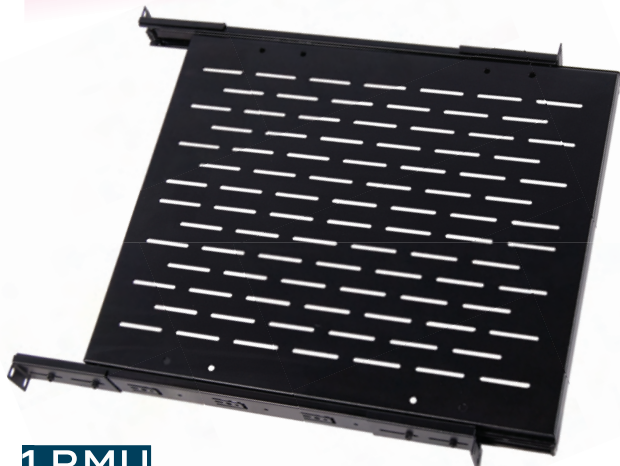

Only compatible with 4 post rack

[Four-Post Racks](#)

P131

### 1 RMU

Height	Width	Depth	Weight	Capacity
1.75 in	19 in	25-36 in	10 lb	44 lb



#### Features:

- o 1 RMU 19-inch vented sliding shelf
- o Fits standard 4-post 19-inch racks
- o Vented design for improved airflow
- o High-quality SPCC cold rolled steel construction
- o Includes 8x sets of M6 screws, washers, and cage nuts
- o Supports up to 44 pounds load capacity
- o Adjustable depth from 25 to 36 inches
- o Suitable for network equipment and components

Item #	Description
047-WSS-3551	1 RMU, 19 in Vented Sliding Shelf

\*SKU: 047-WSN-0050

## 2 RMU 19 in Heavy-Duty Adjustable Shelf



Only compatible with 4 post rack

**Heavy-Duty Adjustable Shelves keep your rack organized, clutter-free, and looking sleek.**



### 2 RMU

Height	Width	Depth	Weight	Capacity
3.5 in	19 in	22-42 in	13 lb	220 lb

#### Features:

- o Heavy-duty adjustable shelf for standard 4-post 19-inch racks
- o High-quality SPCC cold rolled steel construction
- o Includes hardware and mounting set (16x \*M6 screws, cage nut, washers)
- o Adjustable depth from 22 to 42 inches
- o Suitable for network equipment, components, and keyboards

Item #	Description
047-WAS-2400	2 RMU, 4 point, Heavy Duty Adjustable Shelf

\*SKU: 047-WSN-0600

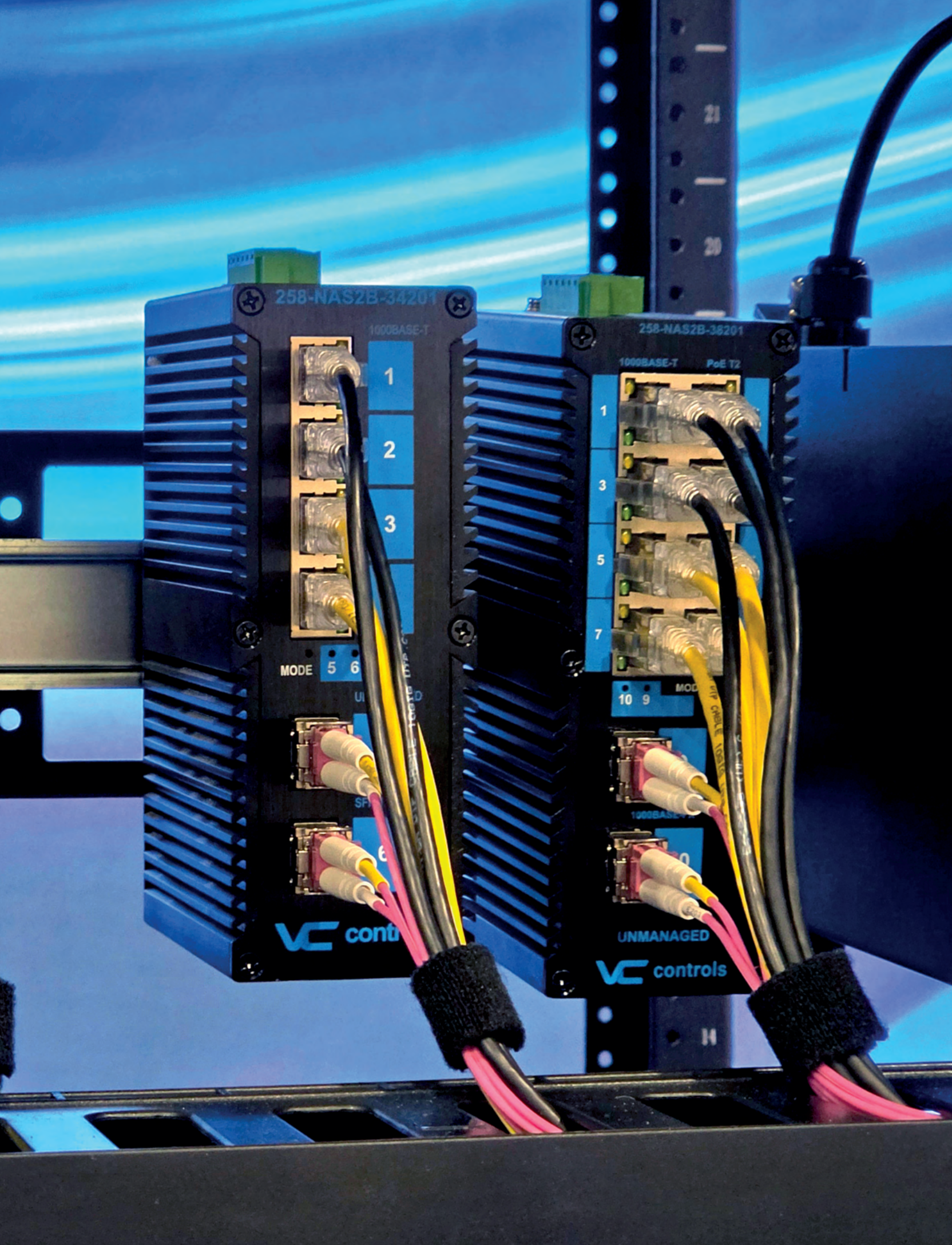

258-NAS2B-34201

1000BASE-T

1

2

3

MODE 5 6

VC controls

258-NAS2B-38201

1000BASE-T PoE T2

1

3

5

7

MODE 10 9

UNMANAGED

VC controls

4.

**INDUSTRIAL & HARSH**

# IP-Rated Boxes

COPPER BULK CABLE

As Delivered (Outlets and Glands are not Included)



253-SMB67-A0



253-SMB67-A1



253-SMB67-A2



253-SMB67-A3



253-SMB67-A4

OPTICAL FIBER BULK CABLE

Application Examples with Installed Outlet Modules and Cable Glands



253-SMB67-A1



253-SMB67-A2



253-SMB67-A3



253-SMB67-A4

Item #	Description
253-SMB67-A0	Surface-Mount Box, Blank/Unported, IP66/67
253-SMB67-A1	Surface-Mount Box, 1-Port – 1-Left-In 1-Left-Out, Blank, IP66/67
253-SMB67-A2	Surface-Mount Box, 2-Port – 2-Left-In/2-Right-Out, Blank, IP66/67
253-SMB67-A3	Surface-Mount Box, 1-Port – 1-Left-In/1-Top-Out, Blank, IP66/67
253-SMB67-A4	Surface-Mount Box, 2-Port – 2-Left-In/2-Top-Out, Blank, IP66/67

**Included:**  
 1 × base  
 (with integral sealing gasket);  
 1 × cover;  
 4 × cover screws;  
 4 × wood screws for surface mounting;  
 4 × cover screw hole plugs



CABLE MANAGEMENT & RACKS

## Cable Glands and Blank Plugs



259-SLC01-F0C1



259-SLC01-F0A1



259-SLC01-F0A2



250-IOM68-A000



259-IMT01-A001



259-SLC02-B0F



Item #	Description
259-SLC01-F0C1	Cable Gland, M16, Plastic, 5-mm-10-mm Cable O.D.*
259-SLC01-F0A1	Cable Gland, M16, Plastic, 2-mm-3-mm Cable O.D.**
259-SLC01-F0A2	Cable Gland, M16, Plastic, 2-mm-3-mm Cable O.D.***
250-IOM68-A000	Blank Plug for Outlet Opening, IP68
259-SLC02-B0F	Blank Plug for Cable Gland Opening, IP68
259-IMT01-A001	Universal Wrench for IP-Rated Connectors

\* Recommended for round twisted-pair and optical fiber cables.  
 \*\* Recommended for simplex round optical fiber cables.  
 \*\*\* Recommended for duplex zipcord optical fiber cables.

Environmental protection: IP66/67.  
 Impact protection: IK07.  
 Cable gland IP rating: IP68.

Dimensions (without outlets and glands):  
 122 mm × 120 mm × 80 mm  
 (4.8 in × 4.7 in × 3.2 in)

INDUSTRIAL & HARSH ENVIRONMENTS

# Outlet/Terminal Modules

## CAT6A Outlet Modules



Item #	Description
250-IOM68-A1A2	Outlet Module Socket-to-IDC CAT6A STP Panel Mounting, IP68
250-IOM68-A2A2	Outlet Module Socket-to-Socket CAT6A STP Panel Mounting, IP68

- o T568A/T568B wiring schemes
- o Conductor gauge: solid: 22-24 AWG
- o 750 mating cycles min
- o IP68

Included with the modules:



## Optical Fiber Outlet Modules



Item #	Description
250-IOM68-A300	Outlet Module Optical Fiber Adapter, Blank White Bezel - Use 263-OFA Series

## Terminal Modules



250-ITM68-A2A2 SECTIONAL VIEW



250-ICP68-B1A2



250-ITM68-B1A2



250-ITM68-D1A2

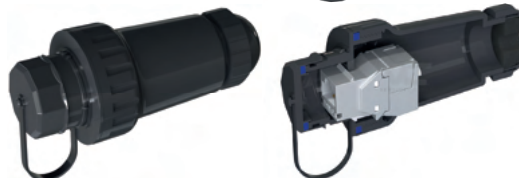

250-ITM68-C031

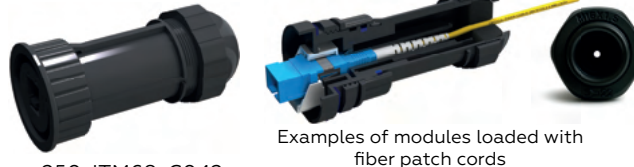

250-ITM68-C042



Item #	Description
250-ITM68-A2A2	Terminal Module, Regular 8P8C Plug with load bar, CAT6A, STP, Stranded, IP68
250-ITM68-B1A2	Terminal Module, Field-Terminatable Ruggedized Plug, CAT6A, STP, Solid, IP68
250-ITM68-D1A2	Terminal Module, Socket-to-IDC, CAT6A, STP, IP68
250-ITM68-C031	Terminal Module, OF Plug Holder, SC SX, Blank, IP68
250-ITM68-C042	Terminal Module, OF Plug Holder, LC DX, Blank, IP68
250-ICP68-B1A2	Coupler Module for 250-ITM68-B Terminal Modules, Socket-to-Socket, CAT6A STP, IP68

COPPER BULK CABLE

OPTICAL FIBER BULK CABLE

CABLE MANAGEMENT & RACKS

INDUSTRIAL & HARSH ENVIRONMENTS

# 250-IOM/250-ITM Accessories & Ruggedized Patch Cords

COPPER BULK CABLE

## Accessories for 250-IOM and 250-ITM Series

250-IOM68-0A-10



250-IOM68-0B



Item #	Description
250-IOM68-0A-10	Sealing Gasket Rubber for 250-IOM68-A Modules, Replacement, Pack of 10
250-IOM68-0B	Protective End Cap for Outlet Modules, IP68
250-ITM68-0A-10	Compression Fitting for 250-ITM68-B Modules, 8.5-mm (0.35-in) cable O.D., Pack of 10
250-ITM68-0B-10	Compression Fitting for 250-ITM68-A Modules, 6-mm (0.24-in) cable O.D., Pack of 10
250-ITM68-0C-10	Compression Fitting for 250-ITM68-C Modules
250-ITM68-0D-10	Sealing Gasket for 250-IOM68-D Modules, Rubber, Pack of 10
250-ITM68-0E	Protective End Cap for Plug Terminal Modules, IP68



OPTICAL FIBER BULK CABLE

250-ITM68-0A-10



250-ITM68-0B-10



250-ITM68-0C-10



250-ITM68-0D-10



250-ITM68-0E



## Ruggedized Patch Cords - Armored OSP Cords

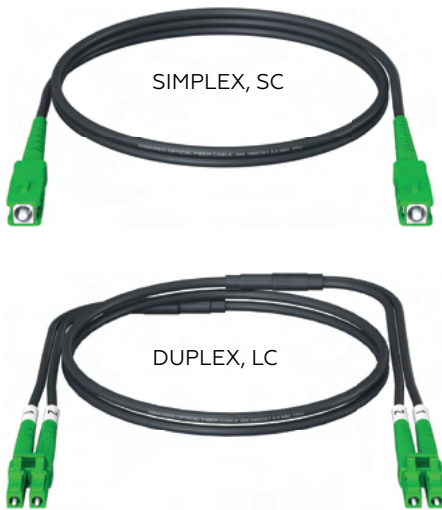

SC-SC (SIMPLEX)	OF Class	1 m	2 m	3 m
	OM3	255-COA3F551Y1M	255-COA3F551Y2M	255-COA3F551Y3M
SM APC	255-COAAF551Y1M	255-COAAF551Y2M	255-COAAF551Y3M	
SM UPC	255-COAF551Y1M	255-COAF551Y2M	255-COAF551Y3M	
LC-LC (SIMPLEX)	OF Class	1 m	2 m	3 m
	OM3	255-COA3F771Y1M	255-COA3F771Y2M	255-COA3F771Y3M
SM APC	255-COAAF771Y1M	255-COAAF771Y2M	255-COAAF771Y3M	
SM UPC	255-COAF771Y1M	255-COAF771Y2M	255-COAF771Y3M	
SC-SC (DUPLICATION)	OF Class	1 m	2 m	3 m
	OM3	255-COA3F661Y1M	255-COA3F661Y2M	255-COA3F661Y3M
SM APC	255-COAAF661Y1M	255-COAAF661Y2M	255-COAAF661Y3M	
SM UPC	255-COAF661Y1M	255-COAF661Y2M	255-COAF661Y3M	
LC-LC (DUPLICATION)	OF Class	1 m	2 m	3 m
	OM3	255-COA3F881Y1M	255-COA3F881Y2M	255-COA3F881Y3M
SM APC	255-COAAF881Y1M	255-COAAF881Y2M	255-COAAF881Y3M	
SM UPC	255-COAF881Y1M	255-COAF881Y2M	255-COAF881Y3M	

Custom lengths available upon request

CABLE MANAGEMENT & RACKS

## CABLE ASSEMBLIES » APPLICATION-SPECIFIC ASSEMBLIES

### Simplex SC-APC assemblies



Item #	Description
255-CAAF551Y05M	Cable assembly, SC-APC to SC-APC, Simplex, TPU Jacket, 3-mm, Black, 5-m Length
255-CAAF551Y10M	Cable assembly, SC-APC to SC-APC, Simplex, TPU Jacket, 3-mm, Black, 10-m Length
255-CAAF551Y15M	Cable assembly, SC-APC to SC-APC, Simplex, TPU Jacket, 3-mm, Black, 15-m Length
255-CAAF551Y20M	Cable assembly, SC-APC to SC-APC, Simplex, TPU Jacket, 3-mm, Black, 20-m Length

INDUSTRIAL & HARSH ENVIRONMENTS

# Copper Coupler Modules

## IP68-Rated



250-ICP68-A1A2 SECTIONAL VIEW



250-ICP68-C1A2



### Features:

- Shielded RJ45 female-to-female coupler
- IP68 Rated - water and dust protection
- For harsh-industrial or outdoor environments
- RoHS-Compliant

Item #	Description
250-ICP68-A1A2	Coupler Module for 250-ITM68-A Terminal Modules, Socket-to-Socket, CAT6A STP, IP68
250-ICP68-B1A2	Coupler Module for 250-ITM68-B Terminal Modules, Socket-to-Socket, CAT6A STP, IP68
250-ICP68-C1A2	Coupler Module, IDC-to-IDC Splice, CAT6A STP, Panel Mounting, IP68



## IP68

An IP68 rating means a device is both dust-tight and waterproof. Specifically, the "6" indicates complete protection against dust ingress, while the "8" signifies the device can withstand submersion in water deeper than 1 meter for a specified duration (usually 30 minutes to 1 hour).

## IP68-Rated



040-381/C6/OWP



040-382/C6A/OWP



### Features:

- Shielded RJ45 female-to-female coupler
- IP68 rated - water and dust protection
- Ideal for harsh-industrial and outdoor environments
- RoHS-Compliant

Item #	Description
040-381/C6/OWP	CAT5E and CAT6 RJ45 Outdoor Waterproof – Shielded Coupler, IP68
040-382/C6A/OWP	CAT6A RJ45 Outdoor Waterproof – Shielded Coupler, IP68

**IP-RATED PRODUCTS**

**Fiber Coupler Modules**



Environmental protection: IP68.

**Features:**

- Shielded RJ45 female-to-female coupler
- IP68 rated for water and dust protection
- Ideal for harsh industrial and outdoor environments
- RoHS compliant

250-ICP68-D4Z2

SECTIONAL VIEW

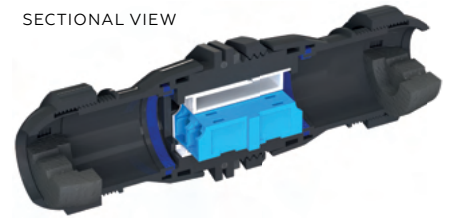

250-ICP68-D4Y2

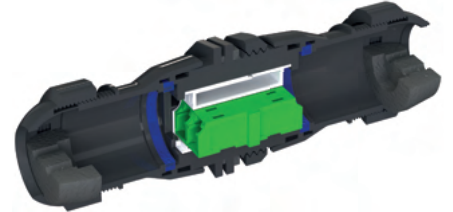

250-ICP68-D4C2

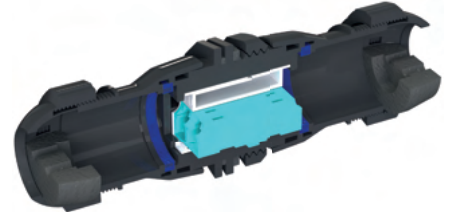

Item #	Description
250-ICP68-D4Z2	Coupler Module, OF Adapter, LC DX, Blue, Panel Mounting, IP68
250-ICP68-D4Y2	Coupler Module, OF Adapter, LC DX, Green, Panel Mounting, IP68
250-ICP68-D4C2	Coupler Module, OF Adapter, LC DX, Aqua, Panel Mounting, IP68



**Accessories**

250-ICP68-0C0A



250-ICP68-0C0B



250-ICP68-0C0C



250-ICP68-0A-10



250-ICP68-DINR



Examples of Brackets with installed coupler modules



250-ICP68-0B-10



Example of Bracket with installed DIN-Rail



Item #	Description
250-ICP68-0C0A	Surface Mounting Bracket for 250-ICP68-A/C/D Coupler Modules, 1-position
250-ICP68-0C0B	Surface Mounting Bracket for 250-ICP68-A/C/D Coupler Modules, 2-position
250-ICP68-0C0C	Surface Mounting Bracket for 250-ICP68-A/C/D Coupler Modules, 3-position
250-ICP68-0A-10	Sealing Gasket for 250-ICP68-A/C/D Coupler Modules, Internal, Rubber, Pack of 10
250-ICP68-0B-10	Sealing Gasket for 250-ICP68-A/C/D Coupler Modules, External, Rubber, Pack of 10
250-ICP68-DINR	DIN-Rail Clip



# Ruggedized Field-Terminatable Plugs

## Category 6A Ruggedized Field-Terminatable Plugs "toolless"

Item #	Description
252-RMP02-A2A10	Modular Plug, 8P8C, CAT6A, STP, Ruggedized, Field-Terminatable, Pack of 10
252-RMP02-A2B10	Modular Plug, 8P8C, CAT6A, STP, Ruggedized, Field-Terminatable, Slim-Profile, Pack of 10
252-RMP02-A2C10	Modular Plug, 8P8C, CAT6A, STP, Ruggedized, Field-Terminatable, 90-Deg Variable Direction, Pack of 10
012-024/10G	Modular Plug, 8P8C, CAT6A, STP, Field-Terminatable



252-RMP02-A2A



252-RMP02-A2B



252-RMP02-A2C



012-024/10G

### Features:

- T568A/T568B wiring schemes
- Environmental Protection: IP20
- Wiring Schemes: T568A/T568B
- Mating Durability: Level 1, 750 cycles min
- Cable diameter: 5-9 mm
- Supports PoE



**360°**  
coverage



## CAT6A IP20 Coupler Modules



250-ICP20-C1A



250-ICP20-C2A



Includes wiring caps with color coding & zip ties

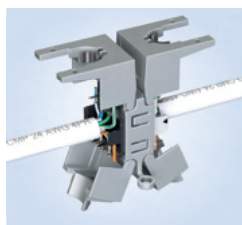

Includes copper foil & zip ties



### Features:

- Category 6A per ANSI/TIA-568.2-D
- Conductor gauge: solid: 22-26 AWG
- Zinc alloy, nickel plating
- Environmental Protection: IP20



### IP20

The IP code (IEC 60529) shows how well an enclosure resists solids and liquids. IP20 means:  
2 → Protection from solid objects >12 mm (like fingers)  
0 → No protection against liquids.  
Best for dry indoor spaces (offices, data centers), not for humid or wet areas

### IoT (Internet of Things)

- Ideal for high-bandwidth IoT applications like cameras, access control, and industrial sensors
- Protects against EMI/RFI interference, which is common in environments with lots of IoT electronics
- Good for structured enclosures in smart building hubs or industrial IoT cabinets

Item #	Description
250-ICP20-C1A	Coupler Module, IDC-to-IDC Splice, <b>Compact</b> , CAT6A STP, Panel Mounting, IP20
250-ICP20-C2A	Coupler Module, IDC-to-IDC Splice, <b>Standard</b> , CAT6A STP, Panel Mounting, IP20

# DIN-RAIL PRODUCTS

COPPER BULK CABLE

## DIN-Rail Keystone Module Holders - Stackable



251-DKH01-A1



251-DKH01-A1-A



251-DKH01-A1-B

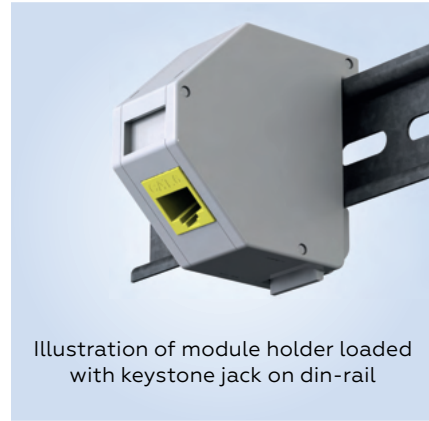

Illustration of module holder loaded with keystone jack on din-rail



### Features:

- Mounting: 35-mm DIN rail
- Labeling: paper insert with clear window
- Compatible with all Vertical Cable keystone inserts. **Note: this product will not work for fiber connections**

Item #	Description
251-DKH01-A1	DIN-Rail Blank Keystone Module Holder, 35-mm, Plastic, Stackable, Grounding, Labeling, One Right Cover, Blank (for twisted-pair systems only)
251-DKH01-A1-A	Left Cover for 251-DKH01-A1
251-DKH01-A1-B	Right Cover for 251-DKH01-A1

OPTICAL FIBER BULK CABLE

## DIN-rail Keystone Module Box - Distribution Box - Fiber and Copper Keystone Inserts

As delivered

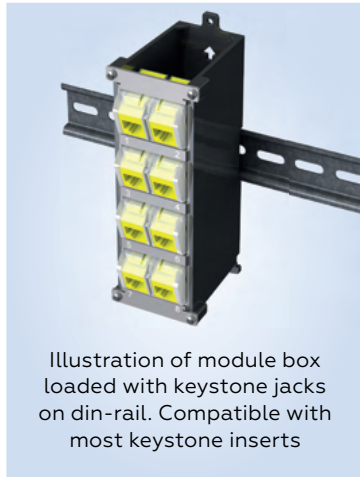

Illustration of module box loaded with keystone jacks on din-rail. Compatible with most keystone inserts

V-Max Keystone Jacks

P54

### Features:

- Mounting: 35-mm DIN rail
- Port numbers (1 to 8), factory-marked; adhesive paper labels, custom labeling
- Compatible with all Vertical Cable keystone inserts. **Note: using fiber inserts watch the bending radius**



Item #	Description
251-DCN01-A8A	Blank DIN-Rail Keystone Module Box, 35-mm, 8-position, Grounding, Swingable

CABLE MANAGEMENT & RACKS

## DIN-rail Keystone Modules - Twisted-Pair Feed-Through Adapter



Illustration of adapter mounted on din-rail

### Features:

- Category 6A per ANSI/TIA-568.2-D
- Dust covers
- Environmental Protection: IP20



Item #	Description
251-DCM01-A1B	DIN-Rail Feed-Through Adapter, CAT6A, STP, 35-mm, Grounding

INDUSTRIAL & HARSH ENVIRONMENTS

## DIN-Rail to Equipment-Rack Adapter Bracket



**Features:**

- 19-inch rack/cabinet compatible (EIA-310-E)
- Up to 22 rack units
- 1.5 millimeter cold-rolled steel construction
- Black powder-coated finish
- Integrated 35 millimeter DIN rail
- Adjustable depth with multiple positions
- Front and rear cable management bars (not included)
- Plastic cable management rings included
- Dual grounding terminals

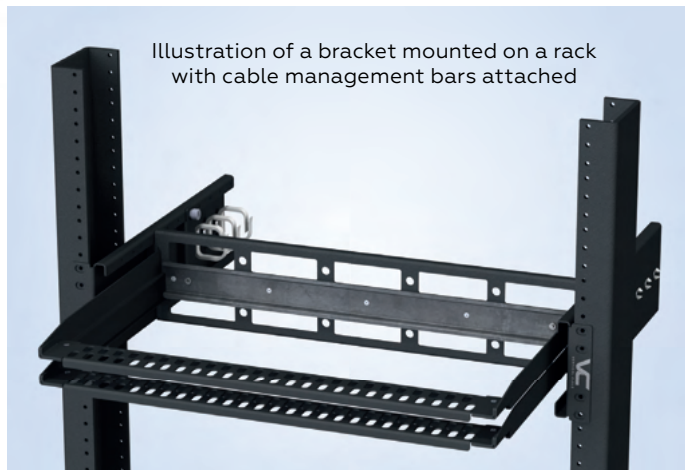

Illustration of a bracket mounted on a rack with cable management bars attached

[Cable management bars](#) [P69](#)

Item #	Description
251-ERA01B-2I	DIN-Rail to Equipment Rack Adapter Bracket, Foldable, 2-RMU, 8-in Depth

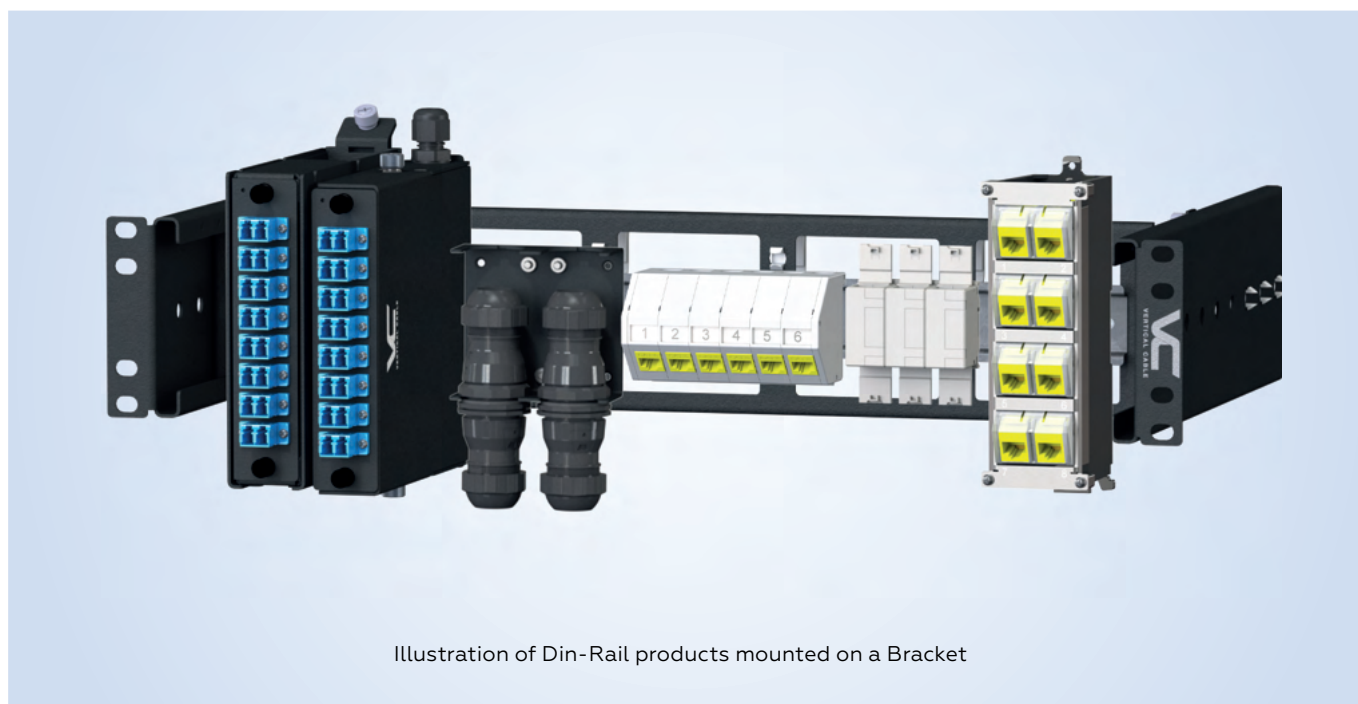

Illustration of Din-Rail products mounted on a Bracket

# Industrial Switches

## Ethernet Switches - DIN-Rail Mount Switches - Unmanaged, PoE Type 2

COPPER BULK CABLE

OPTICAL FIBER BULK CABLE

CABLE MANAGEMENT & RACKS

INDUSTRIAL & HARSH ENVIRONMENTS

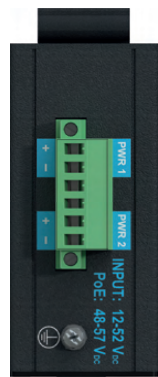
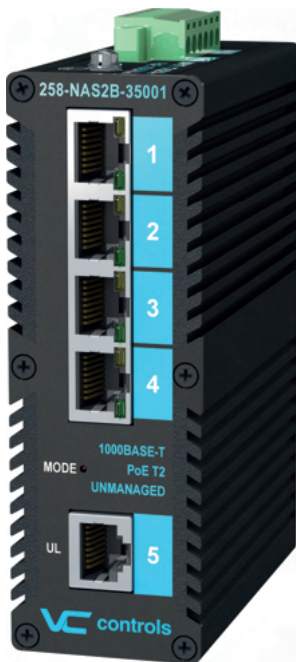

258-NAS2B-35001

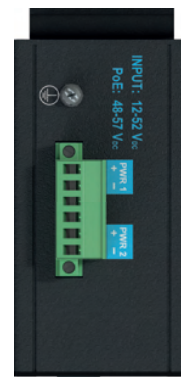
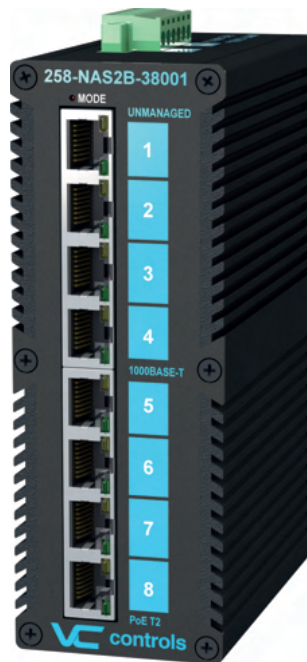

258-NAS2B-38001

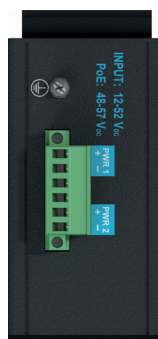
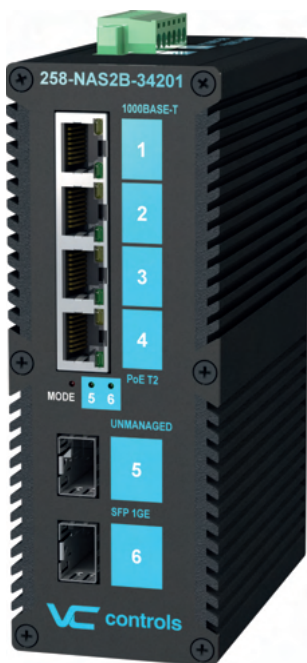

258-NAS2B-34201

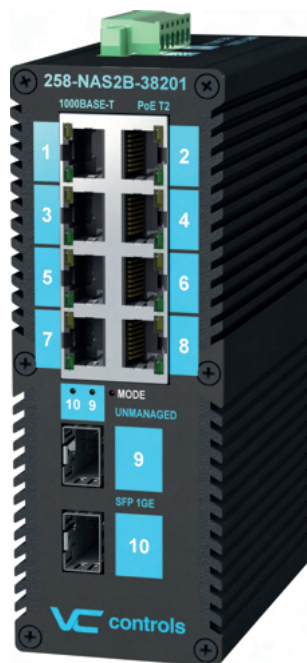

258-NAS2B-38201



### Features:

- Unmanaged; PoE Type 2; redundant power input
- Ruggedized aluminum alloy housing
- Integral metal DIN-rail clip
- Multicolor LEDs
- Operating temperature: -40°C–85°C (-40°F–185°F)
- Power input: 12 VDC–52 VDC
- Power consumption: 5 W max (non-PoE mode)
- FCC CFR47 Part 15
- Directive 2011/65/EU (RoHS2)
- Lifetime limited warranty





Item #	Description
258-NAS2B-35001	Industrial Ethernet Switch, 5 TP Ports, 1000 Mbps, Unmanaged, PoE Type 2
258-NAS2B-38001	Industrial Ethernet Switch, 8 TP Ports, 1000 Mbps, Unmanaged, PoE Type 2
258-NAS2B-34201	Industrial Ethernet Switch, 4 TP Ports, 2 SFP Ports, 1000 Mbps, Unmanaged, PoE Type 2
258-NAS2B-38201	Industrial Ethernet Switch, 8 TP Ports, 2 SFP Ports, 1000 Mbps, Unmanaged, PoE Type 2

**Power supply is not included**

# Industrial Switches & SFP Transceivers

## UNMANAGED Ethernet Switches - Comparison Guide



PART NUMBER		258-NAS2B-38201	258-NAS2B-38001	258-NAS2B-35001	258-NAS2B-34201
Switch					
Configuration	RJ-45 Port	8 × 10/100/1000 Mbps	8 × 10/100/1000 Mbps	5 × 10/100/1000 Mbps	4 × 10/100/1000 Mbps
	SFP Port	2 × 1 Gbps	-	-	2 × 1 Gbps
	PoE Port	8	8	4	4
Electrical, PoE	PoE Budget (maximum wattage)	240 W		120 W	
	PoE Type	Type 2			
	Output Power	IEEE 802.3af: 15.4 W max			
		IEEE 802.3af: 30.0 W max			
	Output Voltage	48 VDC –57 VDC			
PoE Type Detention	Dynamic Auto Power Allocation				

## SFP TRANSCEIVERS

### Multimode

258-SFPA1G041K5



258-SFPC10G41K3



### Singlemode

258-SFPA1G04320



258-SFPC10G4310



#### Features:

- Type: SFP and SFP+, hot-pluggable
- Meets the SFP Multi-Source Agreement (MSA)

Item #	Description
258-SFPA1G041K5	SFP Transceiver Module, SFP, 1Gb/s, LC, 850 nm, 500 m, DDM
258-SFPA1G04320	SFP Transceiver Module, SFP, 1Gb/s, LC, 1310 nm, 20 km, DDM
258-SFPC10G41K3	SFP Transceiver Module, SFP+, 10Gb/s, LC, 850 nm, 300 m, DDM
258-SFPC10G4310	SFP Transceiver Module, SFP+, 10Gb/s, LC, 1310 nm, 10 km, DDM



COPPER BULK CABLE

OPTICAL FIBER BULK CABLE

CABLE MANAGEMENT & RACKS

INDUSTRIAL & HARSH ENVIRONMENTS

# INDEX

## A

Access Control Cable **42**  
Audio Cable **32**  
Adapters  
    LGX Adapter Plates **100**  
    Fiber Adapters **102**  
    Cable Entry Adapters **99**  
Anchor Clamps (OSP) **116**  
Array Splice Cassette **110**

## B

Bars, Cable Management **92**  
Blades, Replacement for  
Cleavers **108**  
Blades, Replacement for  
Crimping tools **80**  
Blank Patch Panels **66**  
Boots, Slip-on **79**  
Brackets, OSP **116**  
Brush Panel **70**

## C

Cable Ties **123**  
Cable Entry Adapters **99**  
CAT6A **8**  
    Couplers **56, 57**  
    Jacks **54**  
    Patch Cords **71, 73**  
    Patch Panels **64, 65**  
    Plugs **78**  
    Surface Mount Boxes **63**  
    Outlet modules **145**  
CAT6 **14**  
    Boots **79**  
    Couplers **56, 57**  
    Jacks **54**  
    Junction Boxes **57**  
    Patch Cords **74**  
    Patch Panels **64, 65**  
    Plugs **78**  
    Surface Mount Boxes **63**  
CAT5E **22**  
    Boots **79**  
    Couplers **56, 57**  
    Jacks **54**  
    Junction Boxes **57**  
    Multipair **25**  
    Outdoor **27**  
    Messenger **28**  
    Patch Cords **75**  
    Patch Panels **64, 65**  
CAT3 **30**  
Cassette/Tray **110**  
Coaxial Cable **34**  
Coax Connectors **77**  
Coax Inserts **77**  
Connectivity Node **98**  
Control Cable **42**  
Crimping Tools **80**

## D

D-Rings **124**  
DIN-rail products **150**  
Distribution Box **150**  
Dry Wall Brackets **60**

## E

Epoxy Plugs **107**  
EZ Mount DIN-Rail  
Cassette **99**

## F

Fan-Out Kits **111**  
FC Adapters **103**  
Feedthrough Wall Plates **60**  
Fiber Optics *See Optical  
Fiber Systems*  
Fiber Cleaver **108**  
Filler Panels **70**  
Fire Alarm Cable **48**

## H

Harsh Environment  
Systems **144**  
HDMI Cables **76**  
High Strand Audio Cable **32**  
Horizontal Wire Manager **126**  
Hook and Loop Straps **123**

## I

Industrial and Harsh  
Environment Systems **144**  
    CAT6A Plug Terminal  
    Modules **145**  
    CAT6A Coupler  
    Modules **145**  
    OF Adapter Coupler  
    Modules **148**  
    IP-Rated Boxes **144**  
    Ruggedized Products **146**  
Inserts  
    Keystone Inserts **77**  
    Keystone Modules **90**  
Installation Accessories **116**  
IP-Rated Products **148**  
I-Punch Tool **80**  
Insertion/Extraction Tool  
(LC Plug) **118**

## J

Jacks, Keystone **54**  
J-Hooks **124**  
Junction Box **60**

## L

LC Adapters **102**  
LGX Adapter Plates **100**  
LGX Cassettes **104, 105**  
Light Source **119**

## M

Mechanical Splices **111**  
Mechanical Splice Holders **111**  
Mid-size Wall Plates **61**  
Mini Patch Panels **64**  
Modular Plugs **78**  
Mounting Bases **123**  
MPO Adapters **101**  
MPO Pre-Connectorized  
Solution **104**

## O

One-Click Pen Tool **109**  
Optical Fiber Systems **90**  
    Optical Fiber Cable **84**  
        ISP Tight-buffer **86**  
        OSP Loose-Tube **84**  
    LGX Adapter Plate **100**  
    Rack-Mount Panels **92**  
    Rack-Mount Enclosure **93**  
    Wall-Mount Enclosure **94**  
    Surface- and Wall-  
    Mount Enclosure **96**  
    Splice Closures **115**  
    Fiber Patch Cords **113**  
    Ruggedized Patch Cords **146**  
    Tool Kits **108**  
    Inspection Tools **119**

## P

Panel Covers **64, 65**  
Patch Cords **71**  
Patch Panels **64, 65**  
Phone Cords **30**  
Phone Wire **31**  
Pigtails **112**  
Plenum-Rated Cable Ties **123**  
Plugs **78**  
Power Meter **119**  
Power Strip **127**  
Professional Aramid Fiber  
Scissors **118**  
Punch Down Blocks  
(66 Block) **31**  
Punch Down Tool **80**

## R

Raceways **122**  
Racks **132**  
RG6 Coax Cable **34**  
RG59 Coax Cable **39**  
RG11 Coax Cable **40**  
RJ45 Plugs **78**

## S

SC Adapters **102**  
Screws **127**  
Security & Communication  
Cable **44**  
    Control Cable **42**  
Self-Gripping Cable Ties **123**  
Sheath Cutter **118**  
Shelves **140**  
Shielded Patch Panels **65**  
Sleeves **111**  
Slim Type Patch Cords **73**  
Splice Closures (OSP) **115**  
Splicing Stage **97**  
Splice-on Plugs **106**  
Splice Holders **111**  
Splice Trays/Cassettes **110**  
Splicing Tools **108**  
Splicing Cassettes **105**  
ST Adapters **103**  
Stainless Steel Wall Plates **61**  
Steel Banding (OSP) **117**  
Surface Mount Box **62**  
Surface Raceways and  
Accessories **122**

## T

Telephone Cords **31**  
Telephone Wire **31**  
Termination Instructions  
    Shielded Keystone Jacks **56**  
    Shielded Patch Panels **65**  
Test Leads **119**  
Testers **80**  
Tension Clamps (OSP) **116**  
Tools **80**  
Three-Step Fiber Stripper **118**

## V

Vertical Wire Managers **113**  
VFL (Visual Fault Locator) **119**

## W

Wall-Mounts **132**  
Wall-Mount Brackets **128**  
Waterproof Couplers **147**  
*See IP-Rated Products*  
Wall Plates **59**  
Wire Managers **131**





**Southern Electronics Supply, Inc.**  
345 followers  
5h • @

Less than 2 weeks away for the biggest event in sports. 300,000 Ft of Vertical Cable being picked up and installed for the Super Bowl a few blocks away.



**FOLLOW**  
@verticalcable  
on social media



**JOIN OFFICIAL VC INSTAGRAM PAGE - SCAN**

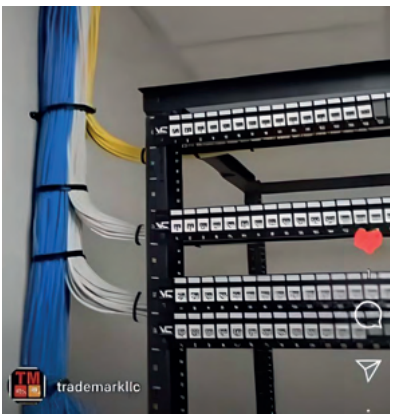
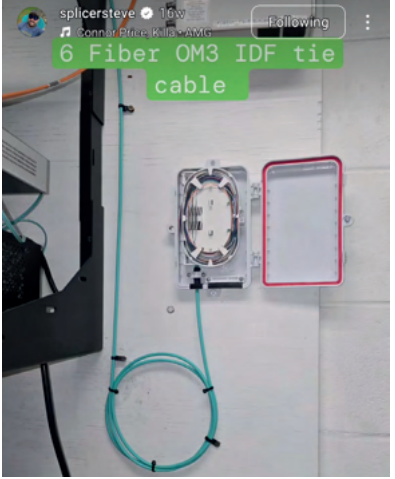

54 boxes goin up to the 10th floor 🙄

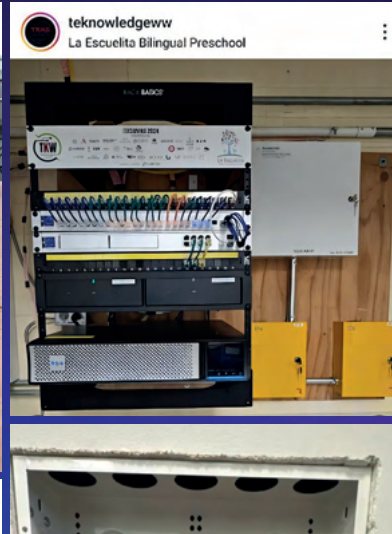

**THANK YOU FOR CHOOSING**

**VERTICAL CABLE**

