

# 9 RMU OPEN WALL MOUNT



## 047-WFJ-0953

Height	Width	Depth	Color	Weight	Capacity
19.5 in.	20 in.	18 in.	Black	15.7 LB	44 LB

### DESCRIPTION

9 RMU Open Wall Mount

### FEATURES

- Steel frame open wall mount with M6 screws and cage nuts.
- Comes unassembled
- Easy assembly

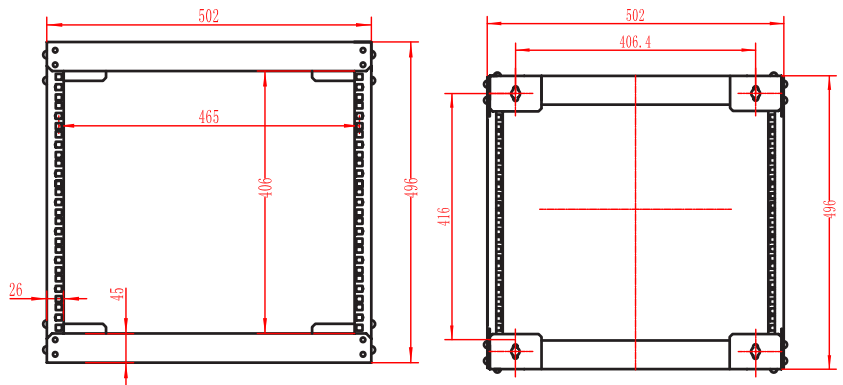

FROM FRONT

FROM REAR

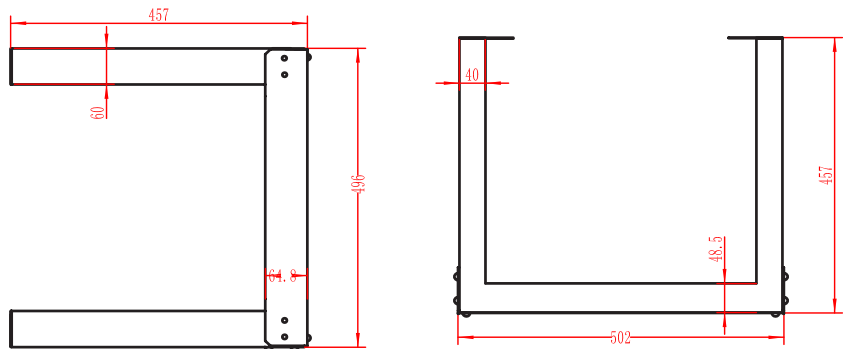

FROM SIDE

FROM TOP

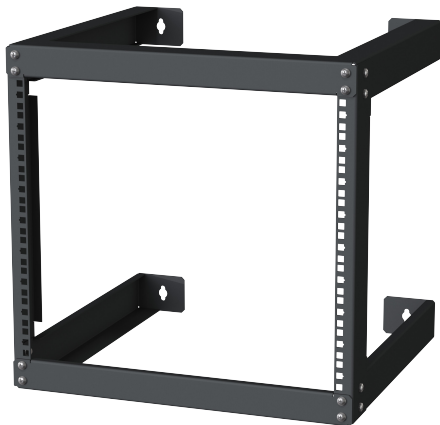

## VERTICAL CABLE

951.696.7772 California  
 800.749.2447 Florida  
 845.391.8318 New York  
 713.322.7242 Texas

[verticalcable.com](http://verticalcable.com)

Rev. 12/2024

Subject to change without notice.